

WORKSTATION SINKS

ARTINOX

WORKSTATION SINKS

UNA STORIA DI PASSIONE

Artinox nasce nel 1985 a Conegliano grazie alla visione di Mario Zanardo, in un territorio dove la lavorazione dell'acciaio inox è tradizione e la cura per il "ben fatto" è un valore radicato. Qui ogni prodotto prende forma attraverso un equilibrio perfetto tra maestria artigianale e precisione industriale. Progettiamo, realizziamo e distribuiamo in tutto il mondo sistemi per cucine di alta gamma, sviluppati per soddisfare le più alte aspettative del mercato.

ARTINOX GROUP

Oltre alla Business Unit WORKSTATION SINKS, il gruppo Artinox si sviluppa anche in altri due rami aziendali, dimostrando come il nostro know-how tecnico e la capacità di innovare possano essere applicati con successo anche nei settori professionale e industriale. Ogni Business Unit offre soluzioni specifiche per il proprio mercato di riferimento, rispondendo alle diverse esigenze pur mantenendo gli stessi valori fondamentali: acciaio inossidabile, qualità e affidabilità.

SHELVING

Sistemi di scaffalature in acciaio inossidabile e polipropilene, ideale per i settori HoReCa, GDO, agroalimentare, ospedaliero, chimico, farmaceutico e navale.

ENCLOSURES

Quadri elettrici in acciaio inossidabile per uso industriale, ideale per i settori alimentare, farmaceutico, chimico, petrolchimico, trasporti e outdoor.



QUALITÀ E RESPONSABILITÀ

Oltre alle eccellenti caratteristiche dei nostri manufatti, siamo impegnati nel miglioramento continuo, con il controllo in ogni fase del processo produttivo, certificato ISO 9001. Adottiamo inoltre soluzioni concrete per ridurre il nostro impatto ambientale - certificazione ISO 14001 - come la produzione di energia pulita tramite l'installazione di pannelli fotovoltaici, contribuendo così a ridurre le emissioni. Responsabilità che guarda al futuro.

DESIGN FUNZIONALE

La cucina è lo spazio che racconta uno stile di vita, dove il tempo assume un valore speciale. Le nostre Workstation diventano ambienti in cui ogni gesto quotidiano si trasforma in eleganza e funzionalità. Nasce così un ambiente fluido, intelligente e sofisticato, pensato per chi considera la cucina non solo uno spazio operativo, ma un vero palcoscenico del proprio stile. Qui funzionalità e design si fondono in un linguaggio senza tempo.

Il sistema sliding permette di utilizzare con naturalezza una gamma raffinata di accessori come griglie, taglieri, contenitori, progettati per accompagnare ogni azione in assoluta armonia.



ACCIAIO INOSSIDABILE SENZA COMPROMESSI

Il nostro acciaio inossidabile AISI 304 accompagna ogni ambiente, domestico o professionale, con prestazioni impeccabili e piena conformità a tutti gli standard di settore. Le sue superfici non porose lo rendono straordinariamente facile da pulire e naturalmente antibatterico. È un materiale inalterabile nel tempo, composto per oltre il 70% da materiali riciclati e completamente riciclabile.

L'ACCIAIO INOSSIDABILE PER L'OUTDOOR

Per la collezione Outdoor abbiamo selezionato l'acciaio AISI 316L, un materiale pregiato impiegato tradizionalmente nel settore nautico e negli ambienti chirurgici. Offre una resistenza eccezionale alla salsedine, rendendolo ideale per gli spazi esterni, dove funzionalità e bellezza devono durare nel tempo.

SOLO 100% MADE IN ITALY

Crediamo che un prodotto progettato e realizzato interamente in Italia rappresenti un valore autentico. Artinox non commercializza semilavorati da assemblare o trasformare: ogni prodotto nasce, viene lavorato e rifinito nei nostri stabilimenti di Conegliano. Un processo che garantisce qualità, durata e sicurezza, rendendo ogni elemento unico e orgogliosamente italiano.



LE FINITURE

Le nostre finiture elevano l'acciaio inossidabile a elemento di design esclusivo. Le collezioni sono disponibili in cinque varianti: la spazzolata, che esalta la sobrietà naturale dell'acciaio AISI 304 e AISI 316L, e Matte Vintage, che dona calore e sofisticata eleganza agli ambienti. Le collezioni Titanium, grazie alla loro resistenza superficiale garantita dal trattamento PVD, con le tonalità Pale Gold, Copper Bronze e Gun Metal, trasformano il metallo in un segno distintivo di stile e carattere.

LAVORAZIONE DI PREGIO

L'intera gamma di prodotti di design è pensata e sviluppata con un approccio tecnico avanzato. Ogni componente è realizzato mediante processi produttivi precisi, capaci di creare forme ergonomiche e sofisticate non ottenibili con metodi convenzionali. I sistemi di saldatura all'avanguardia garantiscono robustezza e perfezione estetica, unendo funzionalità e stile contemporaneo.



Spazzolato



Matte Vintage



PVD Gun Metal spazzolato

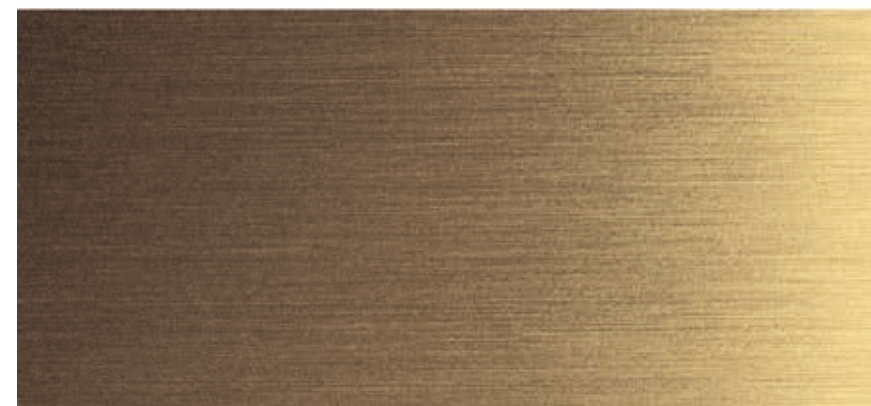

PVD Pale Gold spazzolato



PVD Copper Bronze spazzolato

PLANUM XT

Collezione pg. 68





PLANUM XL

Collezione pg. 62





LAYER BRL

Collezione pg. 80



LAYER SP

Collezione pg. 86



LAYER SBR

Collezione pg. 88



LAYER BRP

Collezione pg. 94

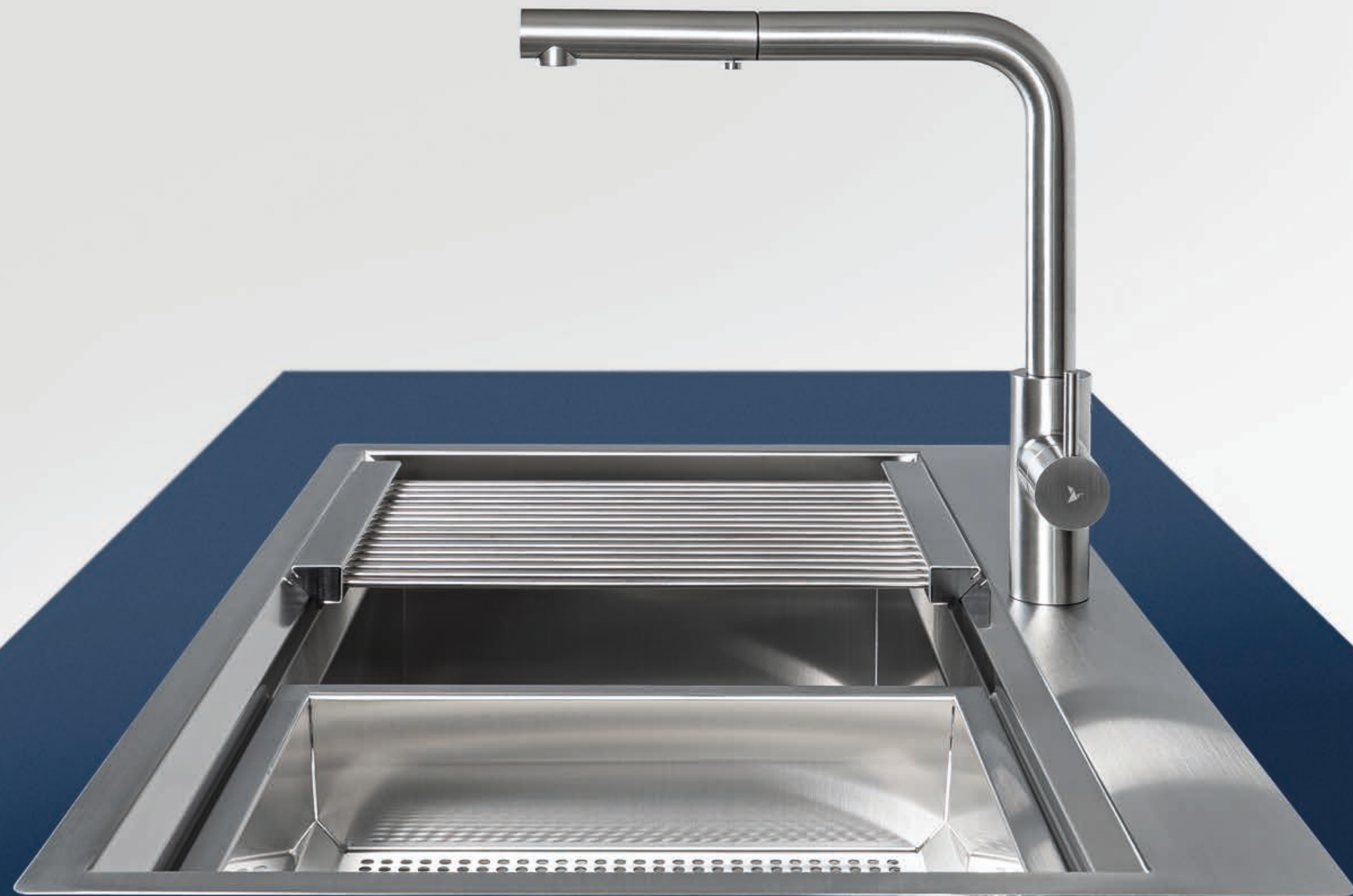

CANALI ATTREZZATI

Collezione pg. 102



LINEA

Collezione pg. 116



SHORE

Collezione pg. 126



GHOST

Collezione pg. 138



RADIUS

Collezione pg. 146



RADIUS XL

Collezione pg. 142



RADIUS MATTE VINTAGE

Collezione pg. 156



MOSE

Collezione pg. 162



AQUA

Collezione pg. 170



NEWGO

Collezione pg. 176



TITANIUM

Collezione pg. 180



PRISMA

Collezione pg. 194



STARTAC MARINA

Collezione pg. 206



GHOST MARINA

Collezione pg. 210



RADIUS MARINA

Collezione pg. 212



I DETTAGLI DEFINISCONO LO STILE

Capacità senza limiti

Tutte le collezioni sono studiate per soddisfare ogni esigenza: disponibili in numerose lunghezze e larghezze, offrono profondità di 170, 200 o 250 mm, garantendo versatilità e funzionalità in ogni ambiente. Capienza e praticità si uniscono in soluzioni progettate per rendere il lavoro quotidiano più semplice e piacevole, con la certezza di una qualità sempre impeccabile.



Accessori che valorizzano la tua cucina

Gli accessori combinano funzionalità e resistenza, rendendo ogni gesto in cucina naturale, armonioso e piacevole. La nostra linea presenta elementi dal design raffinato, ergonomici e pensati per durare nel tempo. Scorrono con eleganza e si puliscono facilmente, anche in lavastoviglie.



Materiali nobili

Oltre all'acciaio inossidabile, le nostre collezioni comprendono componenti e accessori di pregio in Paperstone®, legno naturale e polietilene HD, materiali ecosostenibili, atossici e sicuri per l'uso alimentare. Tutti i materiali provengono da fonti certificate. Il Paperstone® è un composito ecologico, realizzato con carta riciclata e resine naturali, che unisce resistenza, durata ed estetica raffinata. La nostra finitura soft touch e olio naturale, conferisce al materiale un'eleganza ancora maggiore. Leggero ma solido, garantisce praticità e sicurezza anche in lavastoviglie.



Più spazio in cucina

Alcuni modelli delle nostre collezioni sono progettati con uno spazio dedicato al miscelatore. Ogni prodotto è dotato di un solido rinforzo interno che garantisce perfetta stabilità. Sono disponibili uno, due o tre fori, a seconda del tipo di miscelatore scelto, offrendo massima funzionalità e possibilità di personalizzazione.



Sistemi d'acqua in AISI 316L

I nostri miscelatori sono progettati con un approccio tecnico avanzato, pensati per offrire funzionalità superiore. Le linee pure e armoniose si integrano perfettamente con ogni Workstation, combinando stile, praticità e design senza tempo. Realizzati esclusivamente in acciaio inossidabile AISI 316L, garantiscono massima igiene, durata, riciclabilità e resistenza anche negli ambienti più impegnativi e outdoor.



Trooppieno integrato e pilette

Le esclusive pilette 3 ½" garantiscono qualità, durata e stile impeccabile. Tutti i modelli sono in acciaio inossidabile, con sistemi push a saltarello per un'esperienza d'uso fluida e igienica. Perfettamente coordinati con le nostre finiture, uniscono design e funzionalità, con trooppieno integrato senza giunture per massima igiene e facilità di pulizia. Alcune linee sono disponibili senza trooppieno, dove richiesto dal mercato.



UN ALLESTIMENTO PER OGNI STILE

Sopratop

Il sopratop permette sempre la facile installazione su piani di qualsiasi materiale.

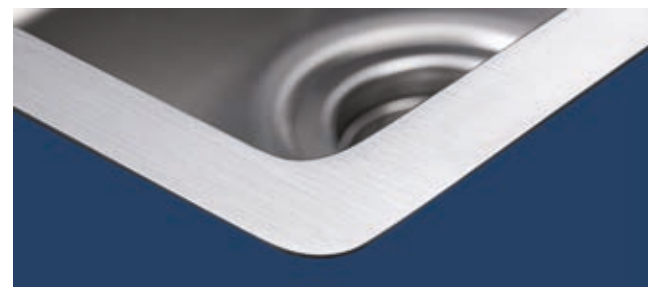

Filotop

L'elegante perimetro a vista filotop ha il bordo rettificato con una tolleranza di due decimi.

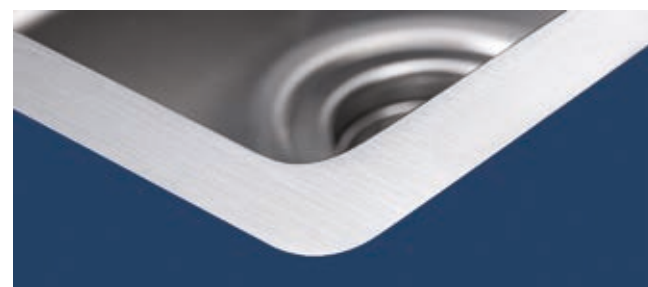

Sottotop

La soluzione sottotop permette di sfruttare al massimo la superficie del piano di lavoro.

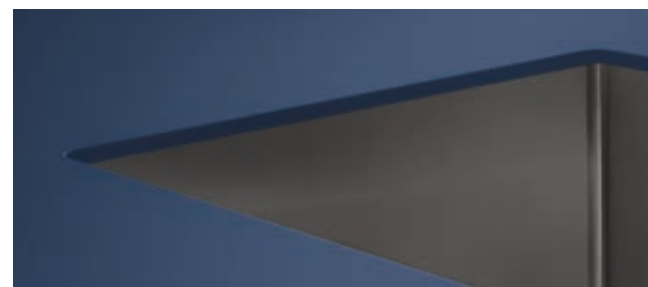

Edgeless

Con Edgeless le giunzioni con il piano di lavoro spariscono. Massima igiene ed estetica.



Fondo Integrato

L'innovativa installazione con fondo in inox e pareti in continuità con il piano di lavoro.



INDICE

WORKSTATIONS

PLANUM	62
LAYER	80

CANALI ATTREZZATI 102

INTEGRATI

LINEA	116
SHORE	126

SINKS

GHOST	138
RADIUS	142
MOSE	162
AQUA	170
NEWGO	176
TITANIUM	180
PRISMA	194

OUTDOOR

STARTAC MARINA	206
GHOST MARINA	210
RADIUS MARINA	212

MISCELATORI	220
-------------	-----

COMPLEMENTI	234
-------------	-----

PRODOTTI PER LA PULIZIA	236
-------------------------	-----

CONDIZIONI DI VENDITA	238
-----------------------	-----



WORKSTATIONS

PLANUM XL

La collezione Planum è caratterizzata da grandi dimensioni e dal doppio sistema sliding dove è possibile far scorrere e abbinare numerosi accessori.

Queste caratteristiche permettono di estendere la funzionalità del piano di lavoro valorizzando al meglio l'esperienza in cucina.



PLANUM XL 141

READY



- Tagliere PaperStone® **55**
- Vaschetta **26**
- Vaschetta inclinata forata **23**
- Griglia **10**
- Set porta-utensili PaperStone® **72**
- Miscelatore Therion **38**
- Miscelatore Therion **38**



Sopratop

Cod. **SAPI14**

PLANUM XL 141

PRO



- Tagliere PaperStone® **55**
- Vaschetta inclinata forata **23**



Sopratop

Cod. **SBPI14**

PLANUM XL 141

SOLO



- | | |
|------------------|---------------|
| Materiale | AISI 304 |
| Finitura | Spazzolato |
| Raggio interno | Saldato 10 mm |
| Misure esterne | 1460 x 510 mm |
| Misure vasca | 1410 x 400 mm |
| Profondità vasca | 254 mm |
| Piletta Plus | 3 1/2" |
| Base | 600 + 900 mm |



Sopratop

Cod. **PI144025**

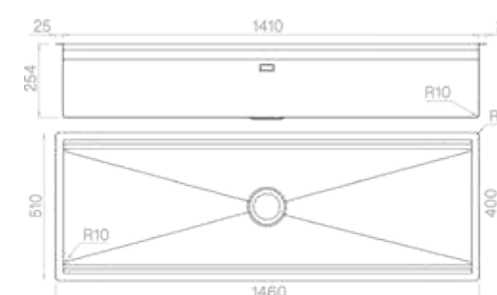

Accessori a pag. 78

PLANUM XL 111 **READY**



- Tagliere PaperStone® **55**
- Vaschetta inclinata forata **23**
- Vaschetta **26**
- Griglia **10**
- Miscelatore Therion **38**
- Miscelatore Therion **38**

 Sopratop Cod. **SAPI11**

PLANUM XL 81 **READY**

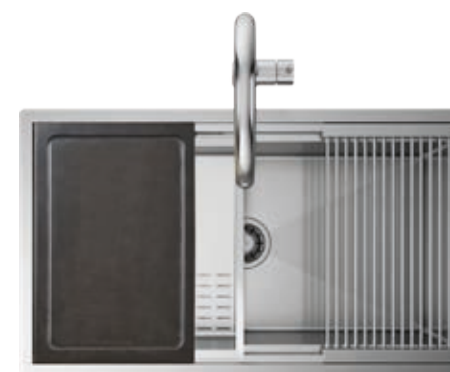

- Tagliere PaperStone® **55**
- Vaschetta inclinata forata **23**
- Griglia **10**
- Miscelatore Therion **38**

 Sopratop Cod. **SAPI81**

PLANUM XL 111 **PRO**



- Tagliere PaperStone® **55**
- Vaschetta inclinata forata **23**

 Sopratop Cod. **SBPI11**

PLANUM XL 81 **PRO**



- Tagliere PaperStone® **55**
- Vaschetta inclinata forata **23**

 Sopratop Cod. **SBPI81**

PLANUM XL 111 **SOLO**



- | | |
|------------------|---------------|
| Materiale | AISI 304 |
| Finitura | Spazzolato |
| Raggio interno | Saldato 10 mm |
| Misure esterne | 1160 x 510 mm |
| Misure vasca | 1110 x 400 mm |
| Profondità vasca | 254 mm |
| Piletta Plus | 3 ½" |
| Base | 1200 mm |

 Sopratop Cod. **PI114025**

PLANUM XL 81 **SOLO**



- | | |
|------------------|---------------|
| Materiale | AISI 304 |
| Finitura | Spazzolato |
| Raggio interno | Saldato 10 mm |
| Misure esterne | 860 x 510 mm |
| Misure vasca | 810 x 400 mm |
| Profondità vasca | 254 mm |
| Piletta Plus | 3 ½" |
| Base | 900 mm |

 Sopratop Cod. **PI814025**

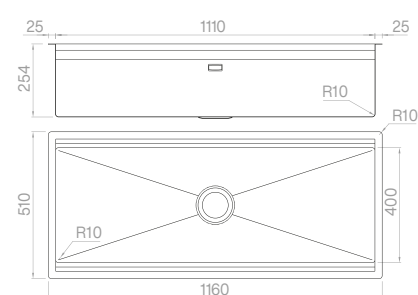

Accessori a pag. 78

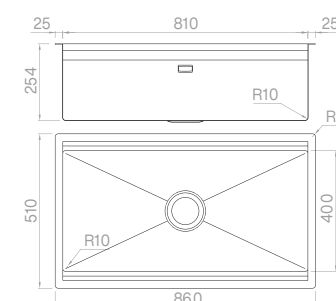

Accessori a pag. 78

PLANUM XL 74

READY



- Tagliere PaperStone®
- Vaschetta inclinata forata
- Griglia
- Miscelatore Therion

- 55
- 23
- 10
- 38



Cod. **SAPI74**

PLANUM XL 74

PRO



- Tagliere PaperStone®
- Vaschetta inclinata forata

- 55
- 23



Cod. **SBPI74**

PLANUM XL 74

SOLO



- | | |
|------------------|---------------|
| Materiale | AISI 304 |
| Finitura | Spazzolato |
| Raggio interno | Saldato 10 mm |
| Misure esterne | 790 x 510 mm |
| Misure vasca | 740 x 400 mm |
| Profondità vasca | 254 mm |
| Piletta Plus | 3 1/2" |
| Base | 800 mm |



Cod. **PI744025**

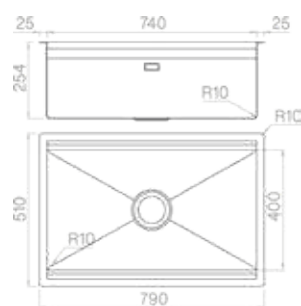

Accessori a pag. 78



PLANUM XT

Mentre il livello superiore ospita innovative superfici di appoggio, come taglieri e griglie realizzati in materiali nobili, il livello inferiore accoglie contenitori pensati per scolare e conservare gli alimenti durante la preparazione.
In foto: complanarità accessori con piano di spessore 20 mm.



PLANUM XT 141

READY



- Tagliere PaperStone® **55**
- Vaschetta **26**
- Vaschetta inclinata forata **23**
- Griglia **10**
- Set porta-utensili PaperStone® **72**
- Miscelatore Therion **38**
- Miscelatore Therion **38**

 Sottotop

Cod. **SAP014XT**

PLANUM XT 141

PRO



- Tagliere PaperStone® **55**
- Vaschetta inclinata forata **23**

 Sottotop

Cod. **SBP014XT**

PLANUM XT 141

SOLO



- | | |
|------------------|---------------|
| Materiale | AISI 304 |
| Finitura | Spazzolato |
| Raggio interno | Saldato 10 mm |
| Misure esterne | 1450 x 490 mm |
| Misure vasca | 1410 x 400 mm |
| Profondità vasca | 234 mm |
| Piletta Plus | 3 1/2" |
| Base | 600 + 900 mm |

 Sottotop

Cod. **P014XT**

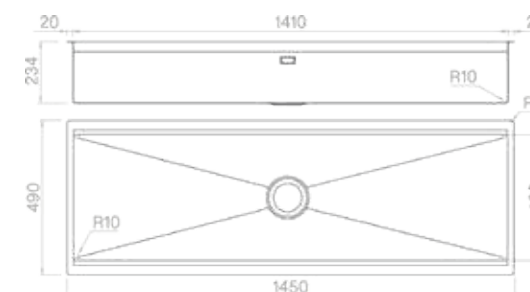

Accessori a pag. 78

PLANUM XT 111 **READY**



- Tagliere PaperStone® **55**
- Vaschetta inclinata forata **23**
- Vaschetta **26**
- Griglia **10**
- Miscelatore Therion **38**
- Miscelatore Therion **38**

 Sottotop Cod. **SAP011XT**

PLANUM XT 81 **READY**



- Tagliere PaperStone® **55**
- Vaschetta inclinata forata **23**
- Griglia **10**
- Miscelatore Therion **38**

 Sottotop Cod. **SAP081XT**

PLANUM XT 111 **PRO**



- Tagliere PaperStone® **55**
- Vaschetta inclinata forata **23**

 Sottotop Cod. **SBP011XT**

PLANUM XT 81 **PRO**



- Tagliere PaperStone® **55**
- Vaschetta inclinata forata **23**

 Sottotop Cod. **SBP081XT**

PLANUM XT 111 **SOLO**



- | | |
|------------------|---------------|
| Materiale | AISI 304 |
| Finitura | Spazzolato |
| Raggio interno | Saldato 10 mm |
| Misure esterne | 1150 x 490 mm |
| Misure vasca | 1110 x 400 mm |
| Profondità vasca | 234 mm |
| Piletta Plus | 3 ½" |
| Base | 1200 mm |

 Sottotop Cod. **P011XT**

PLANUM XT 81 **SOLO**



- | | |
|------------------|---------------|
| Materiale | AISI 304 |
| Finitura | Spazzolato |
| Raggio interno | Saldato 10 mm |
| Misure esterne | 850 x 490 mm |
| Misure vasca | 810 x 400 mm |
| Profondità vasca | 234 mm |
| Piletta Plus | 3 ½" |
| Base | 900 mm |

 Sottotop Cod. **P081XT**

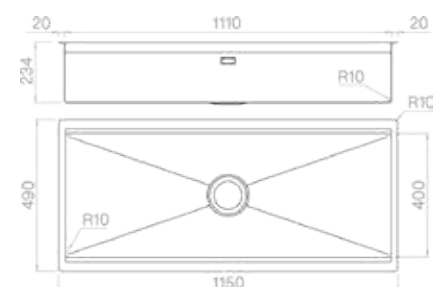

Accessori a pag. 78

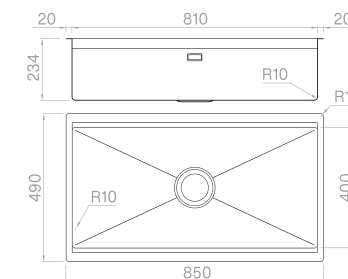

Accessori a pag. 78

PLANUM XT 74

READY



- Tagliere PaperStone® **55**
- Vaschetta inclinata forata **23**
- Griglia **10**
- Miscelatore Therion **38**

 Sottotop Cod. **SAP074XT**

PLANUM XT 74

PRO



- Tagliere PaperStone® **55**
- Vaschetta inclinata forata **23**

 Sottotop Cod. **SBP074XT**

PLANUM XT 74

SOLO



- | | |
|------------------|---------------|
| Materiale | AISI 304 |
| Finitura | Spazzolato |
| Raggio interno | Saldato 10 mm |
| Misure esterne | 780 x 490 mm |
| Misure vasca | 740 x 400 mm |
| Profondità vasca | 234 mm |
| Piletta Plus | 3 ½" |
| Base | 800 mm |

 Sottotop Cod. **P074XT**

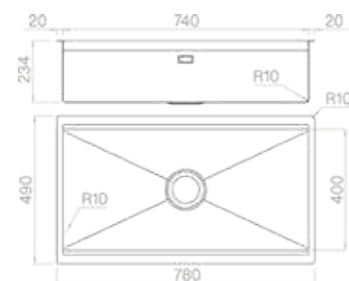

Accessori a pag. 78



DECK PLANUM 141

76



Materiale PaperStone®
Dimensione set 1410 x 460 mm
Tagliere + griglie

Disposizione sul fondo

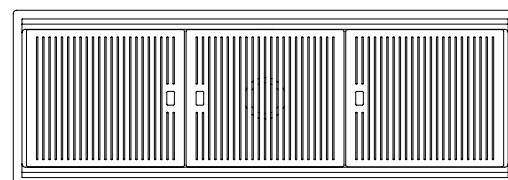

Cod. **SAPDP14**

DECK PLANUM 111

77



Materiale PaperStone®
Dimensione set 1110 x 460 mm
Tagliere + griglie

Disposizione sul fondo

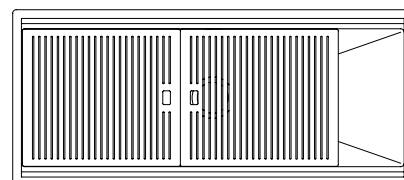

Cod. **SAPDP11**

DECK PLANUM 81

78



Materiale PaperStone®
Dimensione set 810 x 460 mm
Griglie

Disposizione sul fondo

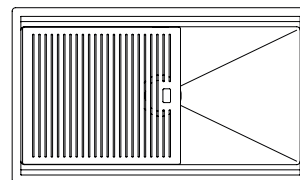

Cod. **SAPDP81**

GRIGLIA

11



Materiale PaperStone®
Dimensione set 398 x 460 mm

Cod. **SAPDP1**



FALSO FONDO 141

79

Materiale
Finitura
Dimensione set

AISI 304
Matte vintage
1406 x 395 mm

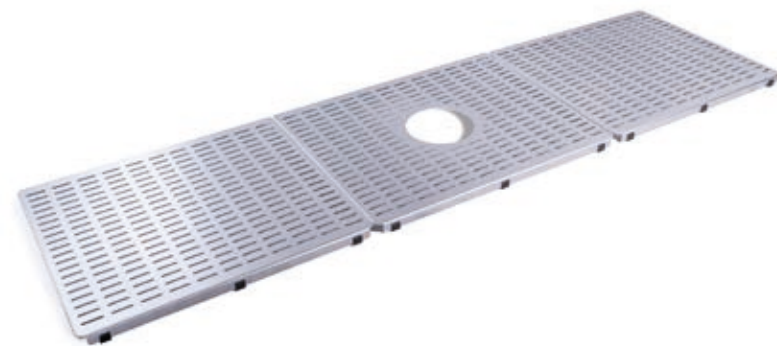

Cod. **AFDP1440**

FALSO FONDO 111

80

Materiale
Finitura
Dimensione set

AISI 304
Matte vintage
1106 x 395 mm



Cod. **AFDP1140**

FALSO FONDO 81

81

Materiale
Finitura
Dimensione set

AISI 304
Matte vintage
806 x 395 mm

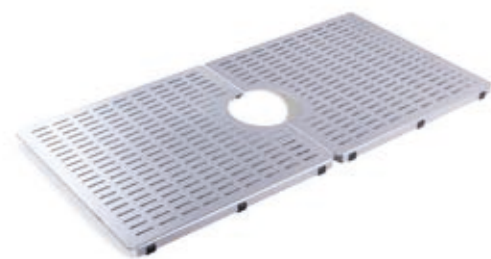

Cod. **AFDP8140**

FALSO FONDO 74

82

Materiale
Finitura
Dimensione set

AISI 304
Matte vintage
736 x 395 mm

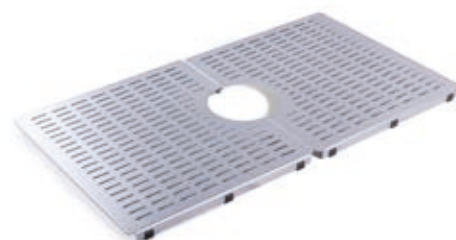

Cod. **AFDP7440**



Livello superiore



Tagliere in legno rovere 1

300x457x26 mm
Cod. **TRIB3045**



Tagliere in PaperStone® 55

300x457x20 mm
Cod. **TRPS3045**



Tagliere piccolo PaperStone® 9

200x457x20 mm
Cod. **TRPS2046**



Set porta utensili rovere 7

130x457x170 mm
Cod. **VPB3C**



PaperStone® Set porta utensili 72

130x457x170 mm
Cod. **VPB3CPA**



Gocciolatoio 8

250x457x20 mm
Cod. **VPB2545**

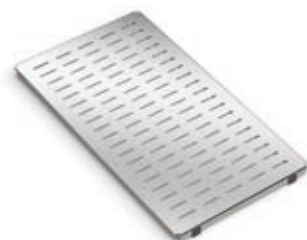

Griglia 10

300x457x25 mm
Cod. **GRS3045**

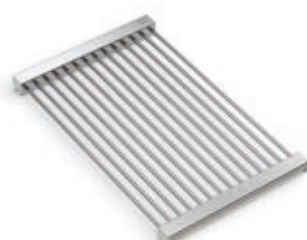

Livello inferiore

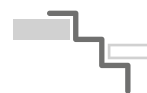

Vaschetta forata 16

190x420x60 mm
Cod. **VQSF2142**



Vaschetta porta piatti 53

300x420x60 mm
Cod. **VQSF2842**



Vaschetta inclinata forata 23

300x420x80/40 mm
Cod. **VQSI2842**



Vaschetta 26

300x420x160 mm
Cod. **VQSP2842**



Gocciolatoio 61

340x420x30 mm
Cod. **VQSI3442**



Set ciotola verdure PaperStone® 2

320x420x120 mm
Cod. **VPVG1P**



Set grattugie PaperStone® 75

200x420x80 mm
Cod. **TI2442GP**



LAYER BRL

Un'estetica essenziale, valorizzata dall'ampia profondità che aumenta la capienza. Ogni accessorio trova il suo posto all'interno dello spazio, scorrendo perfettamente allineato al piano di lavoro. Una Workstation iconica, che rende l'area di lavoro e preparazione altamente funzionale e personalizzabile in infinite combinazioni.

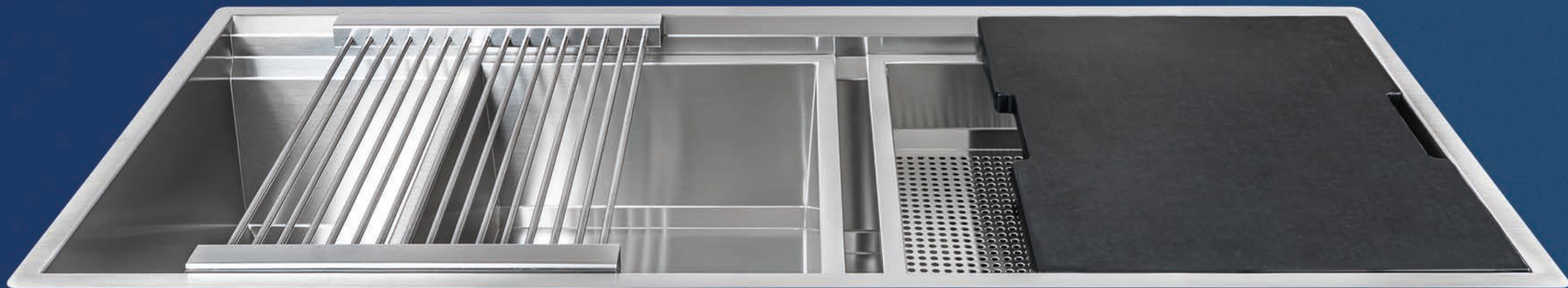

LAYER BRL 104 **READY**



Tagliere in legno
 Vaschetta forata
 Griglia
 Miselatore Circle

4
 48
 14
 52



Cod. **SABRLI10**
 Cod. **SABRLO10**

LAYER BRL 74 **READY**



Tagliere in legno
 Vaschetta forata
 Miselatore Circle

4
 21
 52



Cod. **SABRLI74**
 Cod. **SABRLO74**

LAYER BRL 104 **PRO**



Tagliere in legno
 Vaschetta forata

4
 48



Cod. **SBBRLI10**
 Cod. **SBBRLO10**

LAYER BRL 74 **PRO**



Tagliere in legno

4



Cod. **SBBRLI74**
 Cod. **SBBRLO74**

LAYER BRL 104 **SOLO**



Materiale	AISI 304
Finitura	Spazzolato
Raggio interno	Raggio '0'
Misure esterne	1080 x 510 mm
Misure vasca	960 x 410 mm
Profondità vasca	230 mm
Piletta Plus	3 ½"
Base	1200 mm



Cod. **ALBRLI10**
 Cod. **ALBRLO10**

LAYER BRL 74 **SOLO**



Materiale	AISI 304
Finitura	Spazzolato
Raggio interno	Raggio '0'
Misure esterne	780 x 510 mm
Misure vasca	660 x 410 mm
Profondità vasca	230 mm
Piletta Plus	3 ½"
Base	900 mm



Cod. **ALBRLI74**
 Cod. **ALBRLO74**

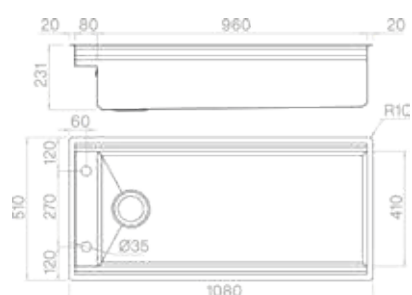

Accessori a pag. 85

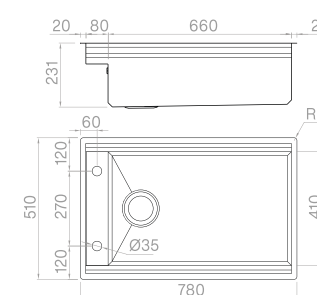

Accessori a pag. 85

LAYER BRL 50

READY



Tagliere in legno
Vaschetta forata
Miscelatore Circle

4
21
52

Sopratop
Sottotop

Cod. **SABRLI50**
Cod. **SABRLO50**

LAYER BRL 50

PRO



Miscelatore Circle

52

Sopratop
Sottotop

Cod. **SBBRLI50**
Cod. **SBBRLO50**

LAYER BRL 50

SOLO



Materiale	AISI 304
Finitura	Spazzolato
Raggio interno	Raggio '0'
Misure esterne	540 x 510 mm
Misure vasca	420 x 410 mm
Profondità vasca	230 mm
Piletta Plus	3 1/2"
Base	600 mm

Sopratop
Sottotop

Cod. **ALBRLI50**
Cod. **ALBRLO50**

Accessori a pag. 85

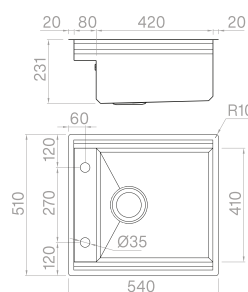

Livello superiore



Tagliere in legno rovere

300x465x20 mm
Cod. **TBRL4634**

4



Griglia

300x465x25 mm
Cod. **GFL4630**

14



Tagliere in PaperStone®

300x465x20 mm
Cod. **TPBR4634**

●



Livello inferiore



Vaschetta forata

190x435x80 mm
Cod. **VFPBRL19**

21



Vaschetta

300x435x160 mm
Cod. **VGBRL34**

28



Vaschetta forata

345x435x80 mm
Cod. **VFGBRL34**

48



LAYER SP

Il design esclusivo si distingue per linee pure e armoniose, caratterizzate dal funzionale sportello sul fondo che nasconde lo scarico al suo interno.



LAYER SP 81

READY

- Tagliere in legno
- Vaschetta forata
- Griglia
- Miscelatore Eos

5
49
15
39

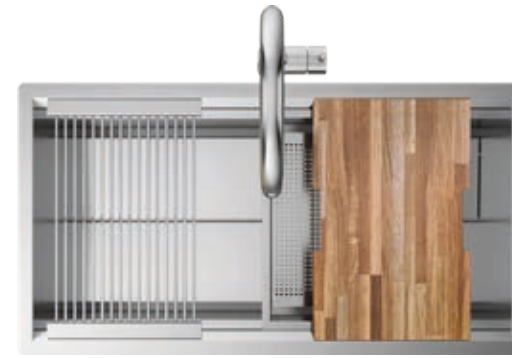

- Sopratop
- Sottotop

Cod. **SASB81SP**
Cod. **SASB81PS**

LAYER SP 81

PRO

- Tagliere in legno
- Vaschetta forata

5
49



- Sopratop
- Sottotop

Cod. **SBSB81SP**
Cod. **SBSB81PS**

LAYER SP 81

SOLO

- | | |
|------------------|--------------|
| Materiale | AISI 304 |
| Finitura | Spazzolato |
| Raggio interno | Raggio '0' |
| Misure esterne | 860 x 450 mm |
| Misure vasca | 810 x 350 mm |
| Profondità vasca | 240 mm |
| Piletta standard | 3 1/2" |
| Base | 900 mm |



- Sopratop
- Sottotop

Cod. **ALSB81SP**
Cod. **ALSB81PS**

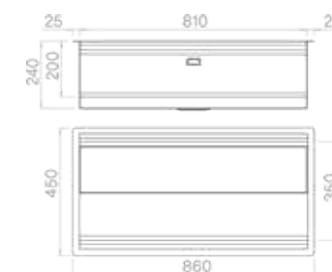

Accessori a pag. 101

LAYER SBR

La forma pura e geometrica di LAYER conserva gli accessori che scorrono sui 2 piani inclinati. Il livello superiore è dedicato a griglie in acciaio inossidabile e taglieri realizzati in materiali pregiati come il PaperStone® e il legno di rovere, mentre al livello sottostante, vaschette e contenitori offrono la massima praticità e funzionalità.



LAYER SBR 104

READY

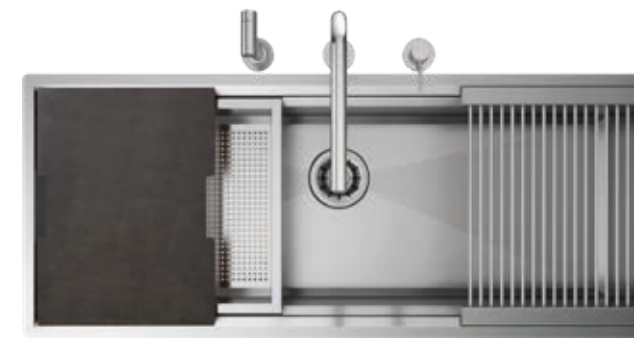

- Tagliere PaperStone®
- Vaschetta forata
- Griglia
- Miscelatore Hidros

57
49
15
40

- Sopratop
- Sottotop

Cod. **SASBR104**
Cod. **SASBRST1**

LAYER SBR 104

PRO



- Tagliere PaperStone®
- Vaschetta forata

57
49

- Sopratop
- Sottotop

Cod. **SBSBR104**
Cod. **SBSBRST1**

LAYER SBR 104

SOLO



- | | |
|------------------|---------------|
| Materiale | AISI 304 |
| Finitura | Spazzolato |
| Raggio interno | Raggio '0' |
| Misure esterne | 1080 x 450 mm |
| Misure vasca | 1040 x 350 mm |
| Profondità vasca | 210 mm |
| Piletta Plus | 3 1/2" |
| Base | 1200 mm |

- Sopratop
- Sottotop

Cod. **SBR104**
Cod. **SBRST104**

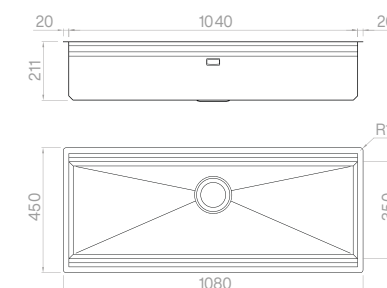

Accessori a pag. 101

LAYER SBR 81 **READY**

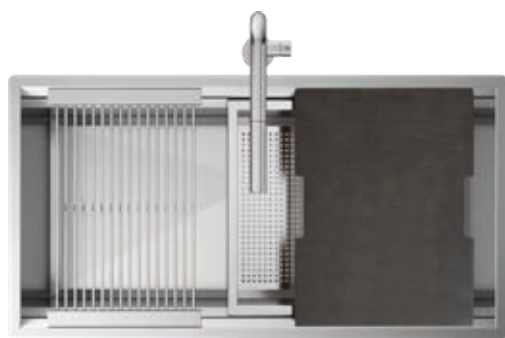

- Tagliere PaperStone®
- Vaschetta forata
- Griglia
- Miscelatore Arion

- 57
- 49
- 15
- 59



Cod. **SASBR81**
Cod. **SASBRST8**

LAYER SBR 81 **PRO**



- Tagliere PaperStone®
- Vaschetta forata

- 57
- 49



Cod. **SBSBR81**
Cod. **SBSBRST8**

LAYER SBR 81 **SOLO**



- | | |
|------------------|--------------|
| Materiale | AISI 304 |
| Finitura | Spazzolato |
| Raggio interno | Raggio '0' |
| Misure esterne | 850 x 450 mm |
| Misure vasca | 810 x 350 mm |
| Profondità vasca | 210 mm |
| Piletta Plus | 3 ½" |
| Base | 900 mm |



Cod. **SBR81**
Cod. **SBRST81**

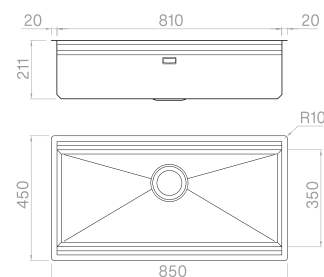

Accessori a pag. 101

LAYER SBR 70 **READY**

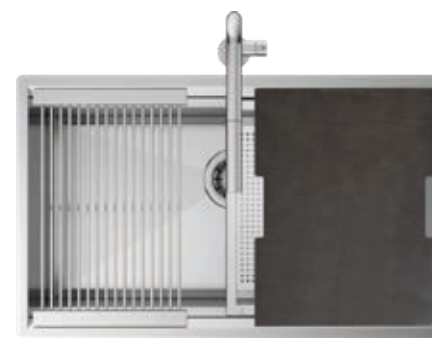

- Tagliere PaperStone®
- Vaschetta forata
- Griglia
- Miscelatore Arion

- 57
- 22
- 15
- 59



Cod. **SASBR70**
Cod. **SASBRST7**

LAYER SBR 70 **PRO**



- Tagliere PaperStone®
- Vaschetta forata

- 57
- 22



Cod. **SBSBR70**
Cod. **SBSBRST7**

LAYER SBR 70 **SOLO**



- | | |
|------------------|--------------|
| Materiale | AISI 304 |
| Finitura | Spazzolato |
| Raggio interno | Raggio '0' |
| Misure esterne | 740 x 450 mm |
| Misure vasca | 700 x 350 mm |
| Profondità vasca | 210 mm |
| Piletta Plus | 3 ½" |
| Base | 800 mm |



Cod. **SBR70**
Cod. **SBRST70**

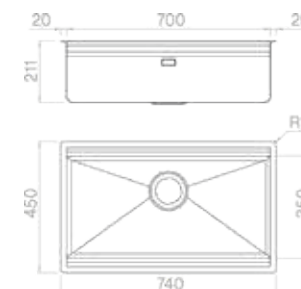

Accessori a pag. 101

LAYER SBR 65 READY

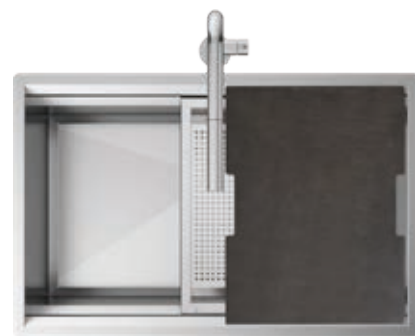

Tagliere PaperStone®
Vaschetta forata
Miscelatore Arion

57
22
59



Cod. **SASBR65**
Cod. **SASBRST6**

LAYER SBR 65 PRO



Tagliere PaperStone®
Vaschetta forata

57
22



Cod. **SBSBR65**
Cod. **SBSBRST6**

LAYER SBR 65 SOLO



Materiale	AISI 304
Finitura	Spazzolato
Raggio interno	Raggio '0'
Misure esterne	690 x 450 mm
Misure vasca	650 x 350 mm
Profondità vasca	210 mm
Piletta Plus	3 ½"
Base	750 mm



Cod. **SBR65**
Cod. **SBRST65**

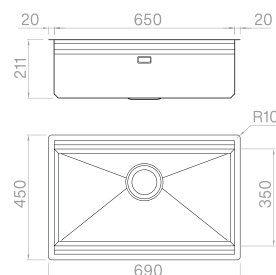

Accessori a pag. 101

LAYER SBR 50 READY



Tagliere PaperStone®
Vaschetta forata
Miscelatore Arion

57
22
59



Cod. **SASBR50**
Cod. **SASBRST5**

LAYER SBR 50 PRO



Tagliere PaperStone®

57



Cod. **SBSBR50**
Cod. **SBSBRST5**

LAYER SBR 50 SOLO



Materiale	AISI 304
Finitura	Spazzolato
Raggio interno	Raggio '0'
Misure esterne	540 x 450 mm
Misure vasca	500 x 350 mm
Profondità vasca	210 mm
Piletta Plus	3 ½"
Base	600 mm



Cod. **SBR50**
Cod. **SBRST50**

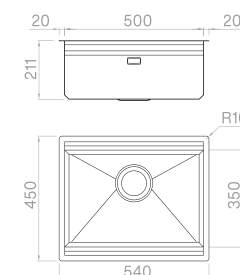

Accessori a pag. 101

LAYER BRP

Un design inclinato esclusivo, che combina estetica e funzionalità su due livelli distinti.

Il piano superiore, dedicato a griglie e taglieri, si accompagna a un livello inferiore dove contenitori studiati esprimono la massima praticità.

La struttura, robusta e raffinata, sostiene il miscelatore con solidità, trasformando LAYER BRP in un elemento versatile e armonioso, capace di coniugare stile, efficienza e facilità di installazione.



LAYER BRP 104

READY



- Tagliere in legno
- Vaschetta forata
- Griglia
- Miscelatore Hidros

5
49
15
40

 Sopratop

Cod. **SABRP104**

LAYER BRP 104

PRO



- Tagliere in legno
- Vaschetta forata

5
49

 Sopratop

Cod. **SBBRP104**

LAYER BRP 104

SOLO



Materiale	AISI 304
Finitura	Spazzolato
Raggio interno	Raggio '0'
Misure esterne	1080 x 510 mm
Misure vasca	1040 x 350 mm
Profondità vasca	210 mm
Piletta Plus	3 1/2"
Base	1200 mm

 Sopratop

Cod. **ALBRP104**

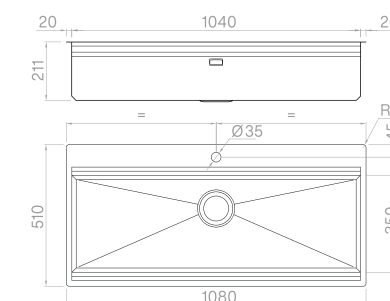

Accessori a pag. 101

LAYER BRP 81 **READY**



- Tagliere in legno
- Vaschetta forata
- Griglia
- Miscelatore Arion

5
49
15
59



Cod. **SABRP81**

LAYER BRP 81 **PRO**



- Tagliere in legno
- Vaschetta forata

5
49

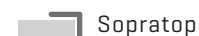

Cod. **SBBRP81**

LAYER BRP 81 **SOLO**



- | | |
|------------------|--------------|
| Materiale | AISI 304 |
| Finitura | Spazzolato |
| Raggio interno | Raggio '0' |
| Misure esterne | 860 x 510 mm |
| Misure vasca | 810 x 350 mm |
| Profondità vasca | 210 mm |
| Piletta Plus | 3 ½" |
| Base | 900 mm |



Cod. **ALBRP81**

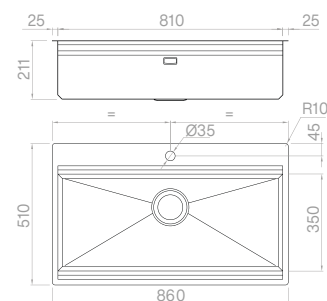

Accessori a pag. 101

LAYER BRP 70 **READY**



- Tagliere in legno
- Vaschetta forata
- Griglia
- Miscelatore Arion

5
22
15
59



Cod. **SABRP70**

LAYER BRP 70 **PRO**



- Tagliere in legno
- Vaschetta forata

5
22



Cod. **SBBRP70**

LAYER BRP 70 **SOLO**



- | | |
|------------------|--------------|
| Materiale | AISI 304 |
| Finitura | Spazzolato |
| Raggio interno | Raggio '0' |
| Misure esterne | 740 x 510 mm |
| Misure vasca | 700 x 350 mm |
| Profondità vasca | 210 mm |
| Piletta Plus | 3 ½" |
| Base | 800 mm |



Cod. **ALBRP70**

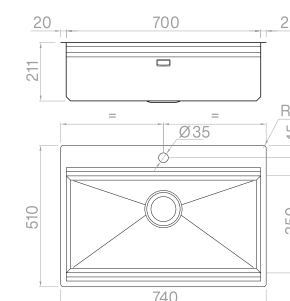

Accessori a pag. 101

LAYER BRP 65 READY

Tagliere in legno
 Vaschetta forata
 Miscelatore Arion

5
 22
 59



Cod. **SABRP65**

LAYER BRP 65 PRO

Tagliere in legno

5



Cod. **SBBRP65**

LAYER BRP 65 SOLO

Materiale	AISI 304
Finitura	Spazzolato
Raggio interno	Raggio '0'
Misure esterne	690 x 510 mm
Misure vasca	650 x 350 mm
Profondità vasca	210 mm
Piletta Plus	3 ½"
Base	750 mm



Cod. **ALBRP65**

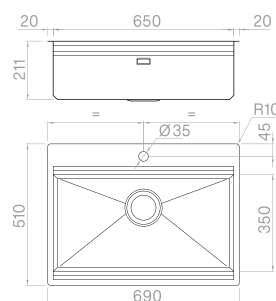

Accessori a pag. 101

LAYER BRP 50 READY

Tagliere in legno
 Vaschetta forata
 Miscelatore Arion

5
 22
 59



Cod. **SABRP50**

LAYER BRP 50 PRO

Tagliere in legno

5



Cod. **SBBRP50**

LAYER BRP 50 SOLO

Materiale	AISI 304
Finitura	Spazzolato
Raggio interno	Raggio '0'
Misure esterne	540 x 510 mm
Misure vasca	500 x 350 mm
Profondità vasca	210 mm
Piletta Plus	3 ½"
Base	600 mm



Cod. **ALBRP50**

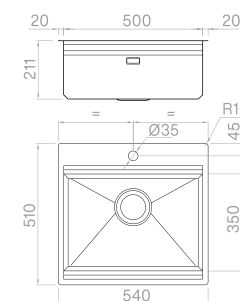

Accessori a pag. 101



 Livello superiore

 Livello inferiore

 Tagliere in legno rovere

5

300x405x20 mm

Cod. **TSBR4030**

 Tagliere in PaperStone®

57

300x405x20 mm

Cod. **TPBR4030**

 Griglia

15

300x405x25 mm

Cod. **GFL4030**

 Vaschetta forata

22

190x375x80 mm

Cod. **VFPSBR19**

 Vaschetta forata

49

300x375x80 mm

Cod. **VFGSBR34**

 Vaschetta

29

300x375x160 mm

Cod. **VGSBR34**

I nostri canali attrezzati sono pensati per ottimizzare lo spazio e aumentare l'ergonomia in cucina. Integrati nel piano cucina profondo almeno 80 cm, consentono di contenere utensili, contenitori e piccoli elettrodomestici, mantenendo tutto a portata di mano. Grazie a questa soluzione, gli elementi normalmente distribuiti in tutta la cucina trovano posto in un'unica struttura, garantendo ordine, funzionalità e libertà progettuale, senza vincoli legati a impianti o attacchi. Disponibili in diverse lunghezze, questi sistemi modulari offrono tre opzioni di installazione, garantendo versatilità e praticità senza compromessi.



CANALI ATTREZZATI



LE INSTALLAZIONI

Ontop

Il canale attrezzato sporge dal piano di 40 mm, risaltando come forma geometrica pura.



MODULARITÀ

12, 10, 8, 6, 5 E 4 UNITÀ

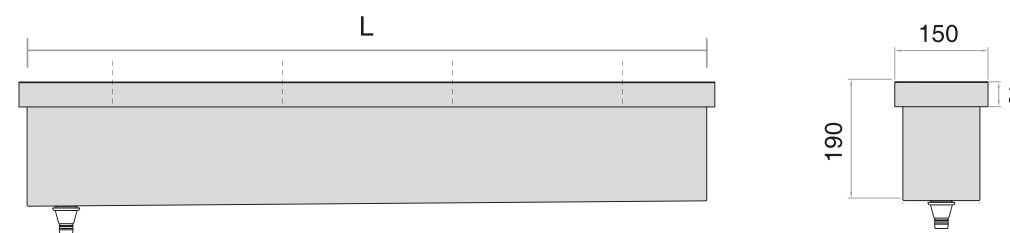

Sopratop

Il sopratop permette sempre la facile installazione su ogni tipologia di piano cucina.



12, 10, 8, 6, 5 E 4 UNITÀ



Sottotop

Questa installazione nascosta permette agli accessori di allinearsi alla superficie del piano.



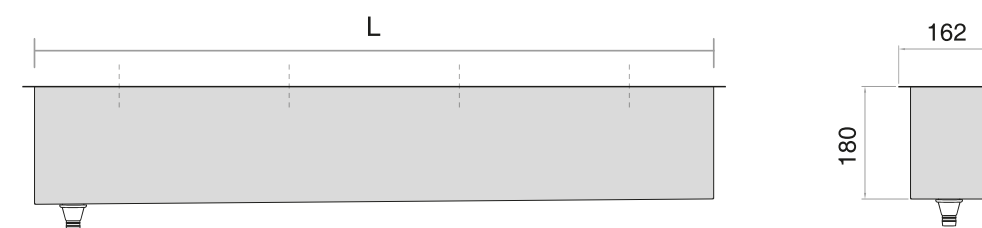

12, 10, 8, 6, 5 E 4 UNITÀ

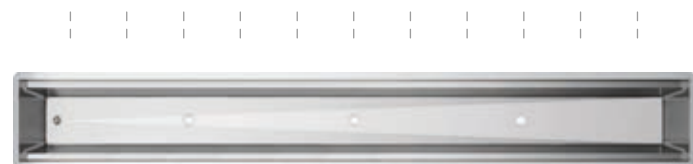

CANALE ATTREZZATO 180





Materiale	AISI 316L
Finitura	Spazzolato
Misure nominali	1634 x 140 mm
Profondità	190 mm
Scarico	Kit incluso
Base	1800 mm
Modularità	12 unità

 Ontop	Cod. CAI18
 Sopratop	Cod. CAG18
 Sottotop	Cod. CA0180

CANALE ATTREZZATO 150





Materiale	AISI 316L
Finitura	Spazzolato
Misure nominali	1362 x 140 mm
Profondità	190 mm
Scarico	Kit incluso
Base	1500 mm
Modularità	10 unità

 Ontop	Cod. CAI15
 Sopratop	Cod. CAG15
 Sottotop	Cod. CA0150

CANALE ATTREZZATO 120





Materiale	AISI 316L
Finitura	Spazzolato
Misure nominali	1090 x 140 mm
Profondità	190 mm
Scarico	Kit incluso
Base	1200 mm
Modularità	8 unità

 Ontop	Cod. CAI12
 Sopratop	Cod. CAG12
 Sottotop	Cod. CA0120

CANALE ATTREZZATO 90





Materiale	AISI 316L
Finitura	Spazzolato
Misure nominali	818 x 140 mm
Profondità	190 mm
Scarico	Kit incluso
Base	900 mm
Modularità	6 unità

 Ontop	Cod. CAI90
 Sopratop	Cod. CAG90
 Sottotop	Cod. CA090

CANALE ATTREZZATO 75





Materiale	AISI 316L
Finitura	Spazzolato
Misure nominali	682 x 140 mm
Profondità	190 mm
Scarico	Kit incluso
Base	750 mm
Modularità	5 unità

 Ontop	Cod. CAI75
 Sopratop	Cod. CAG75
 Sottotop	Cod. CA075

CANALE ATTREZZATO 60



Materiale	AISI 316L
Finitura	Spazzolato
Misure nominali	546 x 140 mm
Profondità	190 mm
Scarico	Kit incluso
Base	600 mm
Modularità	4 unità

 Ontop	Cod. CAI60
 Sopratop	Cod. CAG60
 Sottotop	Cod. CA060

Porta utensili PaperStone®

136x140 mm

Unità: 1

Cod. **PU13PS**

Ripiano forato piccolo PaperStone®

136x140 mm

Unità: 1

Cod. **RPF13PS**

Caricabatteria wireless PaperStone®

136x140 mm

Unità: 1

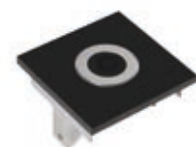
Cod. **CW13PS**

Cassa bluetooth PaperStone®

136x140 mm

Unità: 1

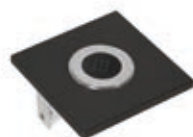
Cod. **CABL13PS**

Dispenser PaperStone®

136 x 140 mm

Unit: 1

Cod. **PD13PS**

Porta miscelatore 1F PaperStone®

136x140 mm

Unità: 1

Cod. **PM13PS**

Porta miscelatore 1F PaperStone®

272x140 mm

Unità: 2

Cod. **PM1FPS**

Porta miscelatore 2F PaperStone®

272x140 mm

Unità: 2

Cod. **PM2FPS**

Porta miscelatore 3F PaperStone®

272x140 mm

Unità: 2

Cod. **PM3FPS**

Vaschetta porta piante PaperStone®

272x140 mm

Unità: 2

Cod. **VPP2HPS**

Ripiano forato grande PaperStone®

272x140 mm

Unità: 2

Cod. **RFG27PS**

Porta coltelli PaperStone®

408x140 mm

Unità: 3

Cod. **VPCL40PS**

Porta utensili

136x140 mm

Unità: 1

Cod. **PU13B**

Ripiano forato piccolo

136x140 mm

Unità: 1

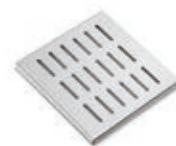
Cod. **RPF13B**

Ripiano forato + supporto device

136x140 mm

Unità: 1

Cod. **RFSD13B**

Caricabatteria wireless

136x140 mm

Unità: 1

Cod. **CW13B**

Cassa bluetooth

136x140 mm

Unità: 1

Cod. **CABL13B**

Porta miscelatore piccolo

136x140 mm

Unità: 1

Cod. **PM13B**

Dispenser

136x140 mm

Unità: 1

Cod. **PD13B**

Porta miscelatore 1F

272x140 mm

Unità: 2

Cod. **PM1FB**

Porta miscelatore 2F

272x140 mm

Unità: 2

Cod. **PM2FB**

Porta miscelatore 3F

272x140 mm

Unità: 2

Cod. **PM3FB**

Ripiano forato grande

272x140 mm

Unità: 2

Cod. **RFG27B**

Vaschetta

272x140 mm

Unità: 2

Cod. **VASF27B**

Vaschetta porta piante

272x140 mm

Unità: 2

Cod. **VPP2HB**

Vaschetta + porta piatti

272x140 mm

Unità: 2

Cod. **VPP27B**

Presca elettrica a scomparsa

272x140 mm

Unità: 2

Cod. **PESVPB**

Porta coltelli legno rovere

408x140 mm

Unità: 3

Cod. **VPCLR40B**

Vaschetta porta ghiaccio

408x140 mm

Unità: 3

Cod. **VAPG40B**



INTEGRATI

LINEA

La particolarità risiede nell'esclusiva installazione Edgeless, dove la giunzione al piano non è visibile. I due elementi, piano cucina e LINEA, si fondono armoniosamente, esaltando una purezza estetica senza paragoni.

Progettata per essere facilmente installata su tutti i materiali e diversi spessori, questa soluzione garantisce una protezione straordinaria dei bordi, migliorandone la resistenza agli urti.

Un sistema intelligente sviluppato in collaborazione con le migliori aziende di lastre in ceramica, per dar vita a soluzioni di design esclusivo.



LINEA 70

READY



- Tagliere in legno
- Vaschetta inclinata forata
- Miscelatore Eos

3
23
39

Edgeless

Cod. **SAL70**

LINEA 70

PRO



- Vaschetta forata

16

Edgeless

Cod. **SBL70**

LINEA 70

SOLO



- | | |
|------------------|---------------|
| Materiale | AISI 304 |
| Finitura | Spazzolato |
| Raggio interno | Saldato 10 mm |
| Misure vasca | 700 x 400 mm |
| Profondità vasca | 200 mm |
| Piletta standard | 3 1/2" |
| Base | 800 mm |

Edgeless 7 mm
Edgeless 13 mm
Edgeless 21 mm

Cod. **L70**
Cod. **L70F13**
Cod. **L70F21**

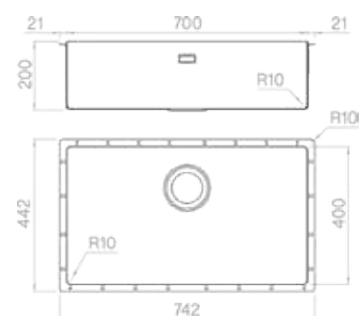

Accessori a pag. 125

LINEA 65

READY



- Tagliere in legno
- Vaschetta inclinata forata
- Miscelatore Eos

3
23
39

Edgeless

Cod. **SAL65**

LINEA 65

PRO



- Vaschetta forata

16

Edgeless

Cod. **SBL65**

LINEA 65

SOLO



- | | |
|------------------|---------------|
| Materiale | AISI 304 |
| Finitura | Spazzolato |
| Raggio interno | Saldato 10 mm |
| Misure vasca | 650 x 400 mm |
| Profondità vasca | 200 mm |
| Piletta standard | 3 1/2" |
| Base | 750 mm |

Edgeless 13 mm

Cod. **L65F13**

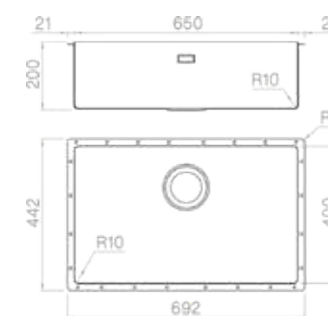

Accessori a pag. 125

LINEA 50

READY

Vaschetta forata
Miscelatore Eidos

16
46



Edgeless

Cod. **SAL50**

LINEA 50

PRO

Vaschetta forata

16



Edgeless

Cod. **SBL50**

LINEA 50

SOLO

Materiale	AISI 304
Finitura	Spazzolato
Raggio interno	Saldato 10 mm
Misure vasca	500 x 400 mm
Profondità vasca	200 mm
Piletta standard	3 1/2"
Base	600 mm

Edgeless 7 mm
Edgeless 13 mm
Edgeless 21 mm

Cod. **L50**
Cod. **L50F13**
Cod. **L50F21**

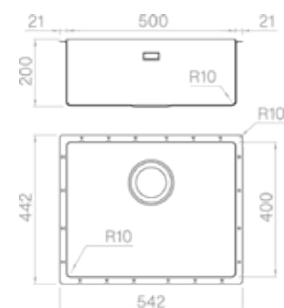

Accessori a pag. 125

LINEA 45

READY

Vaschetta forata
Miscelatore Eidos

16
46



Edgeless

Cod. **SAL45**

LINEA 45

PRO

Vaschetta forata

16



Edgeless

Cod. **SBL45**

LINEA 45

SOLO

Materiale	AISI 304
Finitura	Spazzolato
Raggio interno	Saldato 10 mm
Misure vasca	450 x 400 mm
Profondità vasca	200 mm
Piletta standard	3 1/2"
Base	600 mm

Edgeless 13 mm

Cod. **L45F13**

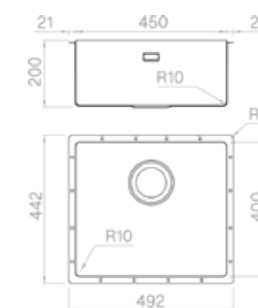

Accessori a pag. 125

LINEA 40

READY

Vaschetta forata
Miscelatore Eidos

16
46



Edgeless

Cod. **SAL40**

LINEA 40

PRO

Vaschetta forata

16



Edgeless

Cod. **SBL40**

LINEA 40

SOLO

Materiale	AISI 304
Finitura	Spazzolato
Raggio interno	Saldato 10 mm
Misure vasca	400 x 400 mm
Profondità vasca	200 mm
Piletta standard	3 ½"
Base	450 mm



Edgeless 13 mm

Cod. **L40F13**

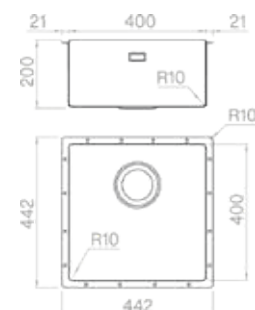

Accessori a pag. 125

LINEA 34

READY

Vaschetta forata
Miscelatore Eidos

16
46



Edgeless

Cod. **SAL34**

LINEA 34

PRO

Vaschetta forata

16



Edgeless

Cod. **SBL34**

LINEA 34

SOLO

Materiale	AISI 304
Finitura	Spazzolato
Raggio interno	Saldato 10 mm
Misure vasca	340 x 400 mm
Profondità vasca	200 mm
Piletta standard	3 ½"
Base	450 mm



Edgeless 13 mm

Cod. **L34F13**

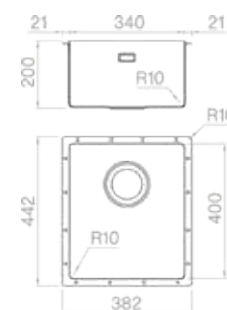

Accessori a pag. 125



Tagliere in legno rovere

3

300x420x20 mm

Cod. **TRIB3042**



Tagliere in PaperStone®

73

200x420x20 mm

Cod. **TRPS2042**



Tagliere in PaperStone®

54

300x420x20 mm

Cod. **TRPS3042**



Griglia

12

300x420x25 mm

Cod. **GRS2542**



Vaschetta forata

16

190x420x60 mm

Cod. **VQSF2142**



Vaschetta inclinata forata

23

300x420x110/60 mm

Cod. **VQSI2842**

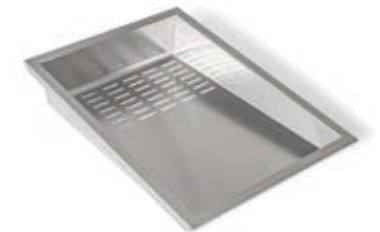

Vaschetta

26

300x420x160 mm

Cod. **VQSP2842**



Vaschetta porta piatti

53

300x420x60 mm

Cod. **VQSF2842**



Goggiolatoio

61

340x420x30 mm

Cod. **VQSI3442**



Set grattugie PaperStone®

75

200x420x80 mm

Cod. **TI24426P**



SHORE

Nasce da un concept innovativo: pareti interne rivestite dallo stesso materiale del piano di lavoro, sostenute e protette sul retro da angoli saldati che preservano la lavorazione superficiale, garantendo solidità e una durata senza tempo.

Il fondo, lasciato a vista e definito da un esclusivo perimetro inclinato, offre un valore estetico distintivo e allo stesso tempo una protezione avanzata.

Questa soluzione difende dagli urti che potrebbero danneggiare anche i materiali più duri e delicati, e assicura una totale resistenza agli shock termici:

le naturali micro-dilatazioni vengono assorbite dall'acciaio, evitando nel tempo la formazione di microfessurazioni.



SHORE 70

READY



Vaschetta forata
Miscelatore Eidos

16
46

 Integrato 12 mm Cod. **SASH70**

SHORE 70

PRO



Vaschetta forata

16

 Integrato 12 mm Cod. **SBSH70**

SHORE 70

SOLO



Materiale	AISI 304
Finitura	Spazzolato
Raggio interno	Saldato 0 mm
Misure esterne	766 x 466 mm
Misure vasca	700 x 400 mm
Profondità vasca	175 mm
Piletta standard	3 ½"
Base	800 mm

 Integrato 12 mm Cod. **SH70**

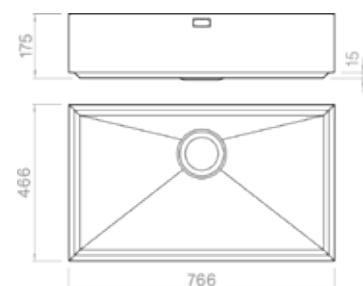

Accessori a pag. 135

 **20 mm** Su richiesta

SHORE 65

READY



Vaschetta forata
Miscelatore Eidos

16
46

 Integrato 12 mm Cod. **SASH65**

SHORE 65

PRO



Vaschetta forata

16

 Integrato 12 mm Cod. **SBSH65**

SHORE 65

SOLO



Materiale	AISI 304
Finitura	Spazzolato
Raggio interno	Saldato 0 mm
Misure esterne	716 x 466 mm
Misure vasca	650 x 400 mm
Profondità vasca	175 mm
Piletta standard	3 ½"
Base	750 mm

 Integrato 12 mm Cod. **SH65**

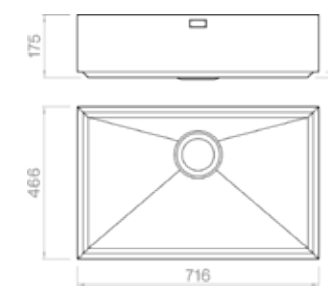

Accessori a pag. 135

 **20 mm** Su richiesta

SHORE 50

READY



Vaschetta forata
Miscelatore Eidos

16
46

 Integrato 12 mm Cod. **SASH50**

SHORE 50

PRO



Vaschetta forata

16

 Integrato 12 mm Cod. **SBSH50**

SHORE 50

SOLO



Materiale	AISI 304
Finitura	Spazzolato
Raggio interno	Saldato 0 mm
Misure esterne	566 x 466 mm
Misure vasca	500 x 400 mm
Profondità vasca	175 mm
Piletta standard	3 ½"
Base	600 mm

 Integrato 12 mm Cod. **SH50**

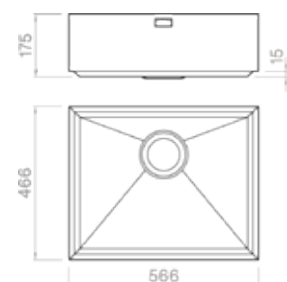

Accessori a pag. 135

 **20 mm** Su richiesta

SHORE 45

READY



Vaschetta forata
Miscelatore Eidos

16
46

 Integrato 12 mm Cod. **SASH45**

SHORE 45

PRO



Vaschetta forata

16

 Integrato 12 mm Cod. **SBSH45**

SHORE 45

SOLO



Materiale	AISI 304
Finitura	Spazzolato
Raggio interno	Saldato 0 mm
Misure esterne	516 x 466 mm
Misure vasca	450 x 400 mm
Profondità vasca	175 mm
Piletta standard	3 ½"
Base	600 mm

 Integrato 12 mm Cod. **SH45**

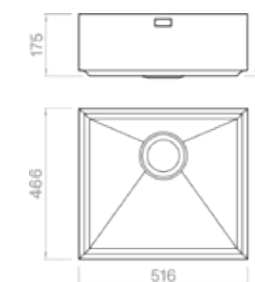

Accessori a pag. 135

 **20 mm** Su richiesta

SHORE 40

READY

Vaschetta forata
Miscelatore Eidos

16
46



Integrato 12 mm

Cod. **SASH40**

SHORE 40

PRO

Vaschetta forata

16



Integrato 12 mm

Cod. **SBSH40**

SHORE 40

SOLO

Materiale	AISI 304
Finitura	Spazzolato
Raggio interno	Saldato 0 mm
Misure esterne	466 x 466 mm
Misure vasca	400 x 400 mm
Profondità vasca	175 mm
Piletta standard	3 ½"
Base	600 mm

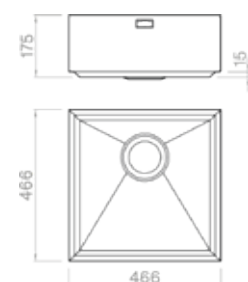

Integrato 12 mm

Cod. **SH40**

Accessori a pag. 135



20 mm Su richiesta

SHORE 34

READY

Vaschetta forata
Miscelatore Eidos

16
46



Integrato 12 mm

Cod. **SASH34**

SHORE 34

PRO

Vaschetta forata

16



Integrato 12 mm

Cod. **SBSH34**

SHORE 34

SOLO

Materiale	AISI 304
Finitura	Spazzolato
Raggio interno	Saldato 0 mm
Misure esterne	406 x 466 mm
Misure vasca	340 x 400 mm
Profondità vasca	175 mm
Piletta standard	3 ½"
Base	450 mm

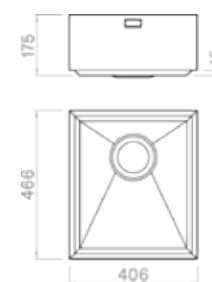

Integrato 12 mm

Cod. **SH34**

Accessori a pag. 135

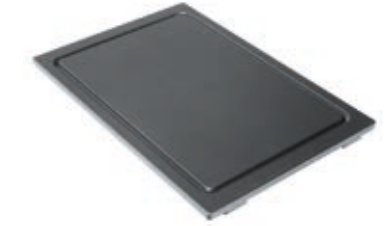
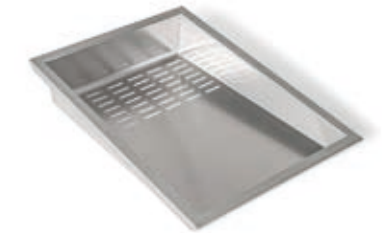

20 mm Su richiesta

**Tagliere in legno rovere****3**300x420x20 mm
Cod. **TRIB3042****Tagliere in PaperStone®****73**200x420x20 mm
Cod. **TRPS2042****Tagliere in PaperStone®****54**300x420x20 mm
Cod. **TRPS3042****Griglia****12**300x420x25 mm
Cod. **GRS2542****Vaschetta forata****16**190x420x60 mm
Cod. **VQSF2142****Vaschetta inclinata forata****23**300x420x110/60 mm
Cod. **VQSI2842****Vaschetta****26**300x420x160 mm
Cod. **VQSP2842****Vaschetta porta piatti****53**300x420x60 mm
Cod. **VQSF2842****Goggiolatoio****61**340x420x30 mm
Cod. **VQSI3442****Set grattugie PaperStone®****75**200x420x80 mm
Cod. **TI24426P**



SINKS

GHOST

La funzionalità rimane al centro del progetto.

È una brillante proposta per unità di dimensioni contenute sempre di livello premium. Il caratteristico abbassamento permette di alloggiare il miscelatore all'interno dell'area operativa, consentendone l'abbattimento fino a creare una superficie complanare con il piano, eventualmente copribile, per ottenere un effetto completamente integrato.

La facilità di pulizia è garantita da angoli interni interamente saldati con raggio 10 mm, indispensabili per offrire comfort e igiene in ogni utilizzo.



GHOST 60

READY

Tagliere PaperStone®
Miscelatore Circle

73

52



 Sopratop
 Filotop
 Sottotop

Cod. **SAGI60RM**Cod. **SAGF60RM**Cod. **SAG060RM**

GHOST 60

PRO

Miscelatore Circle

52



 Sopratop
 Filotop
 Sottotop

Cod. **SBGI60RM**Cod. **SBGF60RM**Cod. **SBG060RM**

GHOST 60

SOLO

Materiale	AISI 304
Finitura	Spazzolato
Raggio interno	Saldato 10 mm
Misure esterne	440 x 520 mm
Misure vasca	400 x 400 + 80 mm
Profondità vasca	65/200 mm
Piletta Plus	3 ½"
Base	600 mm

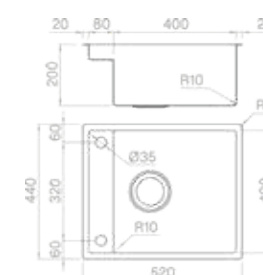

 Sopratop
 Filotop
 Sottotop

Cod. **SIG60RM**Cod. **SFG60RM**Cod. **SSG60RM**

Accessori a pag. 141

Tagliere in legno rovere

3

300x420x20 mm

Cod. **TRIB3042**



Tagliere in PaperStone®

73

200x420x20 mm

Cod. **TRPS2042**



Vaschetta forata

16

190x420x60 mm

Cod. **VQSF2142**



Griglia

12

300x420x25 mm

Cod. **GRS2542**



Set grattugie PaperStone®

75

200x420x80 mm

Cod. **T124426P**



RADIUS XL

La versione a profondità maggiorata è pensata per esigenze contenitive specifiche. È ideale per ambienti che richiedono volumi più capienti, come la lavanderia. Con una profondità superiore a qualsiasi altra proposta sul mercato, XL garantisce massima funzionalità e pulizia senza rinunciare all'eleganza.



RADIUS XL 74

READY

Vaschetta inclinata forata
Miscelatore Eos

23

39

Sopratop / Sottotop Cod. **SABG74XL**

RADIUS XL 74

PRO

Vaschetta forata

16

Sopratop / Sottotop Cod. **SBBG74XL**

RADIUS XL 74

SOLO

Materiale	AISI 304
Finitura	Spazzolato
Raggio interno	Saldato 10 mm
Misure esterne	780 x 440 mm
Misure vasca	740 x 400 mm
Profondità vasca	254 mm
Piletta standard	3 ½"
Base	800 mm

Sopratop / Sottotop Cod. **BG74XL**

Accessori a pag. 155

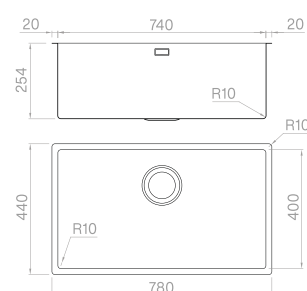

RADIUS XL 50

READY

Vaschetta inclinata forata
Miscelatore Eos

23

39

Sopratop / Sottotop Cod. **SABG50XL**

RADIUS XL 50

PRO

Vaschetta forata

16

Sopratop / Sottotop Cod. **SBBG50XL**

RADIUS XL 50

SOLO

Materiale	AISI 304
Finitura	Spazzolato
Raggio interno	Saldato 10 mm
Misure esterne	540 x 440 mm
Misure vasca	500 x 400 mm
Profondità vasca	254 mm
Piletta standard	3 ½"
Base	600 mm

Sopratop / Sottotop Cod. **BG50XL**

Accessori a pag. 155

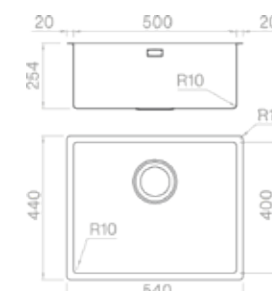

RADIUS

Si distingue per un design essenziale e funzionale, caratterizzato da angoli interni saldati con raggio minimo 10 mm che facilitano la pulizia. La cura costruttiva e la purezza delle geometrie si fondono in una linea equilibrata, sofisticata e adatta a qualsiasi ambiente. La collezione è disponibile in un'ampia gamma di dimensioni.



RADIUS 81

READY

Tagliere in legno
Vaschetta inclinata forata
Miscelatore Hidros

3
23
40



Sopratop
 Filotop
 Sottotop

Cod. **SAB181R1**
 Cod. **SABG81R1**
 Cod. **SABO81R1**

RADIUS 81

PRO

Vaschetta forata

16



Sopratop
 Filotop
 Sottotop

Cod. **SBB181R1**
 Cod. **SBBG81R1**
 Cod. **SBBO81R1**

RADIUS 81

SOLO

Materiale	AISI 304
Finitura	Spazzolato
Raggio interno	Saldato 10 mm
Misure esterne	850 x 440 mm
Misure vasca	810 x 400 mm
Profondità vasca	200 mm
Piletta standard	3 ½"
Base	900 mm



Sopratop
 Filotop
 Sottotop

Cod. **B18140R1**
 Cod. **BG8140R1**
 Cod. **B08140R1**

Accessori a pag. 155

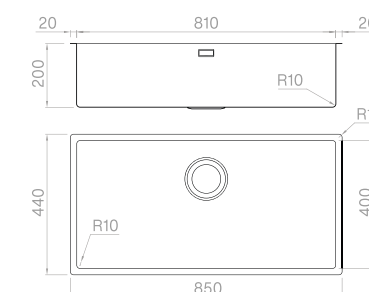

RADIUS 70 READY



Tagliere in legno
Vaschetta inclinata forata
Miscelatore Hidros

3
23
40

— Sopratop
— Filotop
— Sottotop

Cod. **SABI70R1**
Cod. **SABG70R1**
Cod. **SAB070R1**

RADIUS 65 READY



Tagliere in legno
Vaschetta forata
Miscelatore Eos

3
16
39

— Sopratop
— Filotop
— Sottotop

Cod. **SABI65R1**
Cod. **SABG65R1**
Cod. **SAB065R1**

RADIUS 70 PRO



Vaschetta forata

16

— Sopratop
— Filotop
— Sottotop

Cod. **SBBI70R1**
Cod. **SBBG70R1**
Cod. **SBB070R1**

RADIUS 65 PRO



Vaschetta forata

16

— Sopratop
— Filotop
— Sottotop

Cod. **SBBI65R1**
Cod. **SBBG65R1**
Cod. **SBB065R1**

RADIUS 70 SOLO



Materiale	AISI 304
Finitura	Spazzolato
Raggio interno	Saldato 10 mm
Misure esterne	740 x 440 mm
Misure vasca	700 x 400 mm
Profondità vasca	200 mm
Piletta standard	3 ½"
Base	800 mm

— Sopratop
— Filotop
— Sottotop

Cod. **B17040R1**
Cod. **BG7040R1**
Cod. **B07040R1**

RADIUS 65 SOLO



Materiale	AISI 304
Finitura	Spazzolato
Raggio interno	Saldato 10 mm
Misure esterne	690 x 440 mm
Misure vasca	650 x 400 mm
Profondità vasca	200 mm
Piletta standard	3 ½"
Base	750 mm

— Sopratop
— Filotop
— Sottotop

Cod. **B16540R1**
Cod. **BG6540R1**
Cod. **B06540R1**

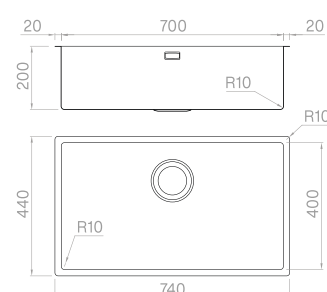

Accessori a pag. 155

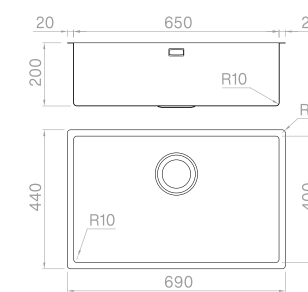

Accessori a pag. 155

RADIUS 55

READY

Vaschetta forata
Miscelatore Eos

16
39



Cod. **SABI55R1**
Cod. **SABG55R1**
Cod. **SAB055R1**

RADIUS 55

PRO

Vaschetta forata

16



Cod. **SBI55R1**
Cod. **SBG55R1**
Cod. **SBB055R1**

RADIUS 55

SOLO

Materiale	AISI 304
Finitura	Spazzolato
Raggio interno	Saldato 10 mm
Misure esterne	590 x 440 mm
Misure vasca	550 x 400 mm
Profondità vasca	200 mm
Piletta standard	3 ½"
Base	600 mm



Cod. **BI5540R1**
Cod. **BG5540R1**
Cod. **B05540R1**

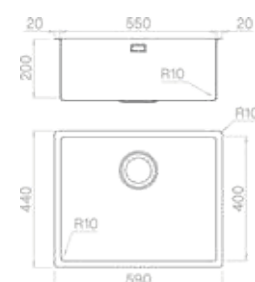

Accessori a pag. 155

RADIUS 50

READY

Vaschetta forata
Miscelatore Eos

16
39



Cod. **SABI50R1**
Cod. **SABG50R1**
Cod. **SAB050R1**

RADIUS 50

PRO

Vaschetta forata

16



Cod. **SBI50R1**
Cod. **SBG50R1**
Cod. **SBB050R1**

RADIUS 50

SOLO

Materiale	AISI 304
Finitura	Spazzolato
Raggio interno	Saldato 10 mm
Misure esterne	540 x 440 mm
Misure vasca	500 x 400 mm
Profondità vasca	200 mm
Piletta standard	3 ½"
Base	600 mm



Cod. **BI5040R1**
Cod. **BG5040R1**
Cod. **B05040R1**

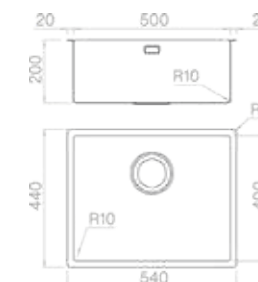

Accessori a pag. 155

RADIUS 45

READY

Vaschetta forata
Miscelatore Eidos

16
46



Cod. **SABI45R1**
Cod. **SABG45R1**
Cod. **SABO45R1**

RADIUS 45

PRO

Vaschetta forata

16



Cod. **SBBI45R1**
Cod. **SBBG45R1**
Cod. **SBBO45R1**

RADIUS 45

SOLO

Materiale	AISI 304
Finitura	Spazzolato
Raggio interno	Saldato 10 mm
Misure esterne	490 x 440 mm
Misure vasca	450 x 400 mm
Profondità vasca	200 mm
Piletta standard	3 ½"
Base	600 mm



Cod. **BI4540R1**
Cod. **BG4540R1**
Cod. **BO4540R1**

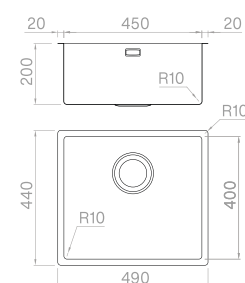

Accessori a pag. 155

RADIUS 40

READY

Vaschetta forata
Miscelatore Eidos

16
46



Cod. **SABI40R1**
Cod. **SABG40R1**
Cod. **SABO40R1**

RADIUS 40

PRO

Vaschetta forata

16



Cod. **SBBI40R1**
Cod. **SBBG40R1**
Cod. **SBBO40R1**

RADIUS 40

SOLO

Materiale	AISI 304
Finitura	Spazzolato
Raggio interno	Saldato 10 mm
Misure esterne	440 x 440 mm
Misure vasca	400 x 400 mm
Profondità vasca	200 mm
Piletta standard	3 ½"
Base	600 mm



Cod. **BI4040R1**
Cod. **BG4040R1**
Cod. **BO4040R1**

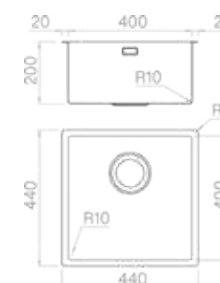

Accessori a pag. 155

RADIUS 34

READY



Vaschetta forata
Miscelatore Eidos

16
46

Sopratop
 Filotop
 Sottotop

Cod. **SAB134R1**
 Cod. **SABG34R1**
 Cod. **SAB034R1**

RADIUS 34

PRO



Vaschetta forata

16

Sopratop
 Filotop
 Sottotop

Cod. **SBB134R1**
 Cod. **SBBG34R1**
 Cod. **SBB034R1**

RADIUS 34

SOLO



Materiale	AISI 304
Finitura	Spazzolato
Raggio interno	Saldato 10 mm
Misure esterne	380 x 440 mm
Misure vasca	340 x 400 mm
Profondità vasca	200 mm
Piletta standard	3 ½"
Base	450 mm

Sopratop
 Filotop
 Sottotop

Cod. **B13440R1**
 Cod. **BG3440R1**
 Cod. **B03440R1**

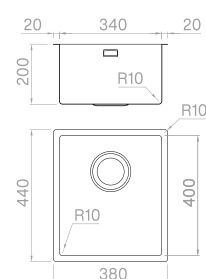

Accessori a pag. 155

Tagliere in legno rovere

3

300x420x20 mm
Cod. **TRIB3042**



Tagliere in PaperStone®

73

200x420x20 mm
Cod. **TRPS2042**



Tagliere in PaperStone®

54

300x420x20 mm
Cod. **TRPS3042**



Griglia

12

300x420x25 mm
Cod. **GRS2542**



Vaschetta forata

16

190x420x60 mm
Cod. **VQSF2142**



Vaschetta inclinata forata

23

300x420x110/60 mm
Cod. **VQSI2842**



Vaschetta

26

300x420x160 mm
Cod. **VQSP2842**



Vaschetta porta piatti

53

300x420x60 mm
Cod. **VQSF2842**



Goggiolatoio

61

340x420x30 mm
Cod. **VQSI3442**



Set grattugie PaperStone®

75

200x420x80 mm
Cod. **TI2442GP**



RADIUS MATTE VINTAGE

Elegante e ricercata, questa finitura esalta il dialogo tra il rigore dell'acciaio inox e il calore di una superficie volutamente irregolare. Il carattere materico è valorizzato e offre una maggiore protezione già dai primi momenti di utilizzo.



RADIUS MATTE VINTAGE 70

READY



Tagliere PaperStone®
Vaschetta inclinata forata
Miscelatore Eos

73

24

39

Sopratop
 Filotop
 Sottotop

Cod. **SABI70RH**

Cod. **SABG70RH**

Cod. **SABO70RH**

RADIUS MATTE VINTAGE 70

PRO



Vaschetta inclinata forata

24

Sopratop
 Filotop
 Sottotop

Cod. **SBBI70RH**

Cod. **SBBG70RH**

Cod. **SBBO70RH**

RADIUS MATTE VINTAGE 70

SOLO



Materiale	AISI 304
Finitura	Matte vintage
Raggio interno	Saldato 10 mm
Misure esterne	740 x 440 mm
Misure vasca	700 x 400 mm
Profondità vasca	200 mm
Piletta Standard	3 ½"
Base	800 mm

Sopratop
 Filotop
 Sottotop

Cod. **B17040RH**

Cod. **BG7040RH**

Cod. **B07040RH**

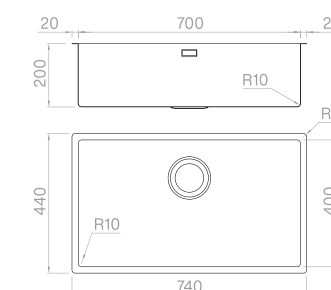

Accessori a pag. 161

RADIUS MATTE VINTAGE 50

READY

Tagliere PaperStone®
Miscelatore Eos

73

39



Cod. **SAB150RH**
Cod. **SABG50RH**
Cod. **SAB050RH**

RADIUS MATTE VINTAGE 50

PRO

Vaschetta inclinata forata

24



Cod. **SBB150RH**
Cod. **SBBG50RH**
Cod. **SBB050RH**

RADIUS MATTE VINTAGE 50

SOLO

Materiale	AISI 304
Finitura	Matte vintage
Raggio interno	Saldato 10 mm
Misure esterne	540 x 440 mm
Misure vasca	500 x 400 mm
Profondità vasca	200 mm
Piletta Standard	3 ½"
Base	600 mm

 Sopratop Cod. **B15040RH**
 Filotop Cod. **BG5040RH**
 Sottotop Cod. **B05040RH**

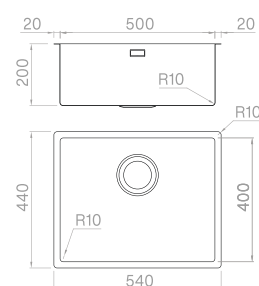

Accessori a pag. 161

RADIUS MATTE VINTAGE 40

READY

Tagliere PaperStone®
Miscelatore Eos

73

39



Cod. **SAB140RH**
Cod. **SABG40RH**
Cod. **SAB040RH**

RADIUS MATTE VINTAGE 40

PRO

Vaschetta inclinata forata

24



Cod. **SBB140RH**
Cod. **SBBG40RH**
Cod. **SBB040RH**

RADIUS MATTE VINTAGE 40

SOLO

Materiale	AISI 304
Finitura	Matte vintage
Raggio interno	Saldato 10 mm
Misure esterne	440 x 440 mm
Misure vasca	400 x 400 mm
Profondità vasca	200 mm
Piletta Standard	3 ½"
Base	600 mm

 Sopratop Cod. **B14040RH**
 Filotop Cod. **BG4040RH**
 Sottotop Cod. **B04040RH**

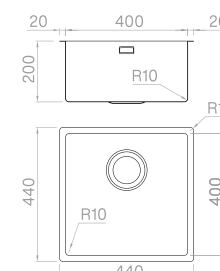

Accessori a pag. 161

**Tagliere in legno rovere**

300x420x20 mm
Cod. **TRIB3042**

**Tagliere PaperStone®**

200x420x20 mm
Cod. **TRPS2042**

**Tagliere in PaperStone®**

300x420x20 mm
Cod. **TRPS3042**

**Griglia matte vintage**

300x420x25 mm
Cod. **GRH2542**

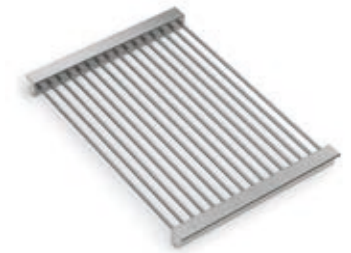
**Vaschetta inclinata forata matte vintage**

300x420x80/40 mm
Cod. **VQHI2842**

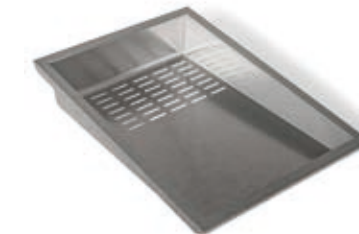
**Vaschetta forata matte vintage**

190x420x60 mm
Cod. **VQHF2142**

**Set grattugie PaperStone®**

200x420x80 mm
Cod. **TI24426P**



MOSE

Un'ampia area di lavoro che integra una partizione interna, studiata per creare due zone funzionali senza separarle in modo netto. Grazie alla sua conformazione ribassata, la partizione permette di utilizzare un unico foro sul piano della cucina e consente lo scorrimento armonioso dei numerosi accessori dedicati, ampliando le possibilità d'uso. L'area operativa non è mai stata così sofisticata, pratica e versatile.



MOSE 91 READY



Tagliere in legno
Vaschetta forata
Miscelatore Eos

3
16
39

Sopratop
 Sottotop

Cod. **SAM91R1**
Cod. **SAM091R1**

MOSE 87 READY



Tagliere in legno
Vaschetta forata
Miscelatore Eos

3
16
39

Sopratop
 Sottotop

Cod. **SAM87R1**
Cod. **SAM087R1**

MOSE 91 PRO



Vaschetta forata

16

Sopratop
 Sottotop

Cod. **SBM91R1**
Cod. **SBM091R1**

MOSE 87 PRO



Vaschetta forata

16

Sopratop
 Sottotop

Cod. **SBM87R1**
Cod. **SBM087R1**

MOSE 91 SOLO



Materiale	AISI 304
Finitura	Spazzolato
Raggio interno	Saldato 10 mm
Misure esterne	910 x 440 mm
Misure vasca	500 x 400 mm / 340 x 400 mm
Profondità vasca	200 mm
Piletta standard	3 ½"
Base	1200 mm

Sopratop
 Sottotop

Cod. **MI9140R1**
Cod. **MO9140R1**

MOSE 87 SOLO



Materiale	AISI 304
Finitura	Spazzolato
Raggio interno	Saldato 10 mm
Misure esterne	870 x 440 mm
Misure vasca	400 x 400 mm / 400 x 400 mm
Profondità vasca	200 mm
Piletta standard	3 ½"
Base	900 mm

Sopratop
 Sottotop

Cod. **MI8740R1**
Cod. **MO8740R1**

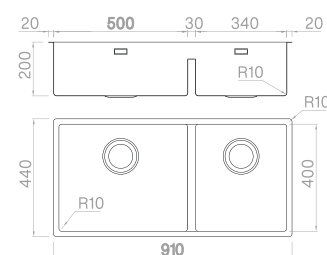

Accessori a pag. 169

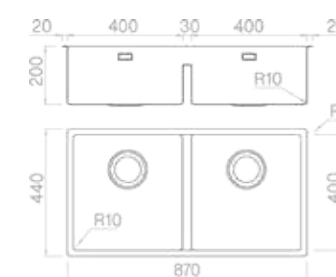

Accessori a pag. 169

MOSE 81 READY



Tagliere in legno
Vaschetta forata
Miscelatore Eos

3
16
39

Sopratop
 Sottotop

Cod. **SAM181R1**
Cod. **SAM081R1**

MOSE 60 READY



Tagliere in legno
Vaschetta forata
Miscelatore Eidos

3
16
46

Sopratop
 Sottotop

Cod. **SAM160R1**
Cod. **SAM060R1**

MOSE 81 PRO



Vaschetta forata

16

Sopratop
 Sottotop

Cod. **SBM181R1**
Cod. **SBM081R1**

MOSE 60 PRO



Vaschetta forata

16

Sopratop
 Sottotop

Cod. **SBM160R1**
Cod. **SBM060R1**

MOSE 81 SOLO



Materiale	AISI 304
Finitura	Spazzolato
Raggio interno	Saldato 10 mm
Misure esterne	810 x 440 mm
Misure vasca	400 x 400 mm / 340 x 400 mm
Profondità vasca	200 mm
Piletta standard	3 ½"
Base	900 mm

Sopratop
 Sottotop

Cod. **M18140R1**
Cod. **M08140R1**

MOSE 60 SOLO



Materiale	AISI 304
Finitura	Spazzolato
Raggio interno	Saldato 10 mm
Misure esterne	590 x 440 mm
Misure vasca	180 x 400 mm / 340 x 400 mm
Profondità vasca	170 / 200 mm
Piletta standard	3 ½"
Base	600 mm

Sopratop
 Sottotop

Cod. **M16040R1**
Cod. **M06040R1**

Accessori a pag. 169

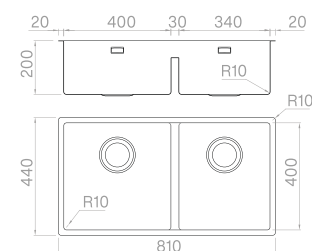

Accessori a pag. 169

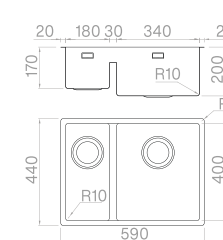

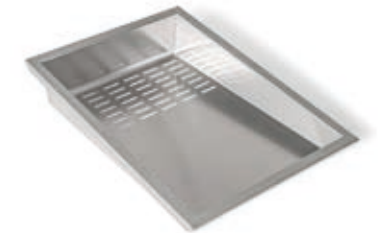
**Tagliere in legno rovere****3**300x420x20 mm
Cod. **TRIB3042****Tagliere in PaperStone®****73**200x420x20 mm
Cod. **TRPS2042****Tagliere in PaperStone®****54**300x420x20 mm
Cod. **TRPS3042****Griglia****12**300x420x25 mm
Cod. **GRS2542****Vaschetta forata****16**190x420x60 mm
Cod. **VQSF2142****Vaschetta inclinata forata****23**300x420x110/60 mm
Cod. **VQSI2842****Vaschetta****26**300x420x160 mm
Cod. **VQSP2842****Vaschetta porta piatti****53**300x420x60 mm
Cod. **VQSF2842****Goggiolatoio****61**340x420x30 mm
Cod. **VQSI3442****Set grattugie PaperStone®****75**200x420x80 mm
Cod. **TI24426P**

AQUA

È un modello dal design essenziale e mono-vasca perfetto per ogni esigenza operativa. Le superfici interne sono saldate a raggio minimo di 10 mm, per unire estetica e funzionalità. Il banco miscelatore è integrato nell'area di lavoro garantendo la massima sicurezza. Un equilibrio perfetto tra eleganza, praticità e robustezza, pensato per ambienti cucina raffinati e contemporanei.



AQUA 81 READY



Tagliere in legno
Vaschetta forata
Miscelatore Arion

3
16
59



Cod. **SAAI81**
Cod. **SAAG81**

AQUA 81 PRO



Vaschetta forata

16



Cod. **SBAI81**
Cod. **SBAG81**

AQUA 81 SOLO



Materiale	AISI 304
Finitura	Spazzolato
Raggio interno	Saldato 10 mm
Misure esterne	850 x 510 mm
Misure vasca	810 x 400 mm
Profondità vasca	200 mm
Piletta standard	3 ½"
Base	900 mm



Cod. **ALAI81**
Cod. **ALAG81**

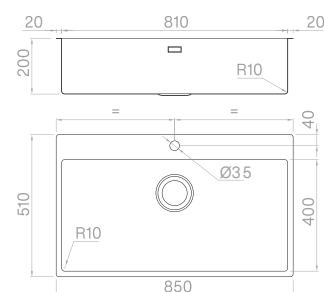

Accessori a pag. 175

AQUA 70 READY



Tagliere in legno
Vaschetta forata
Miscelatore Arion

3
16
59



Cod. **SAAI70**
Cod. **SAAG70**

AQUA 70 PRO



Vaschetta forata

16



Cod. **SBAI70**
Cod. **SBAG70**

AQUA 70 SOLO



Materiale	AISI 304
Finitura	Spazzolato
Raggio interno	Saldato 10 mm
Misure esterne	740 x 510 mm
Misure vasca	700 x 400 mm
Profondità vasca	200 mm
Piletta standard	3 ½"
Base	800 mm



Cod. **ALAI70**
Cod. **ALAG70**

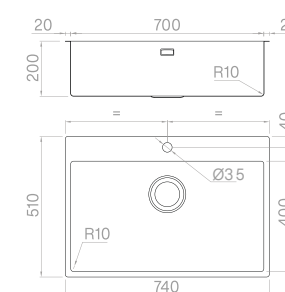

Accessori a pag. 175

AQUA 50

READY



Tagliere in legno
Vaschetta forata
Miscelatore Eidos

3
16
46



Cod. **SAAI50**
Cod. **SAAG50**

AQUA 50

PRO



Vaschetta forata

16



Cod. **SBAI50**
Cod. **SBAG50**

AQUA 50

SOLO



Materiale	AISI 304
Finitura	Spazzolato
Raggio interno	Saldato 10 mm
Misure esterne	540 x 510 mm
Misure vasca	500 x 400 mm
Profondità vasca	200 mm
Piletta standard	3 ½"
Base	600 mm



Cod. **ALAI50**
Cod. **ALAG50**

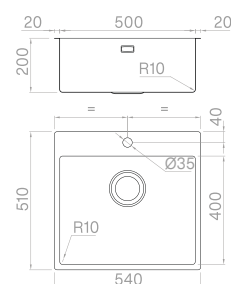

Accessori a pag. 175

Tagliere in legno rovere

3

300x420x20 mm
Cod. **TRIB3042**



Tagliere in PaperStone®

73

200x420x20 mm
Cod. **TRPS2042**



Tagliere in PaperStone®

54

300x420x20 mm
Cod. **TRPS3042**



Griglia

12

300x420x25 mm
Cod. **GRS2542**



Vaschetta forata

16

210x420x60 mm
Cod. **VQSF2142**



Vaschetta inclinata forata

23

300x420x110/60 mm
Cod. **VQSI2842**



Vaschetta

26

300x420x160 mm
Cod. **VQSP2842**



Vaschetta porta piatti

53

300x420x60 mm
Cod. **VQSF2842**



Goggiolatoio

61

340x420x30 mm
Cod. **VQSI3442**



Set grattugie PaperStone®

75

200x420x80 mm
Cod. **TI2442GP**



NEWGO

La cucina si trasforma in uno spazio scenografico e carico di atmosfera, senza rinunciare alla sicurezza. Per noi, la facilità d'uso è sempre al centro. Il perimetro ribassato consente di integrare il miscelatore direttamente nell'area di lavoro, creando una soluzione raffinata e sofisticata, in cui gli accessori scorrono perfettamente a filo piano, coniugando funzionalità ed eleganza formale.



NEWGO 81

READY



Griglia
Vaschetta inclinata forata
Miscelatore Circle

12
23
52



Soprato

Filoto

Cod. **SAGI81**Cod. **SAGG81**

NEWGO 81

PRO



Griglia

12



Soprato

Filoto

Cod. **SBGI81**Cod. **SBGG81**

NEWGO 81

SOLO



Materiale	AISI 304
Finitura	Spazzolato
Raggio interno	Saldato 10 mm
Misure esterne	850 x 530 mm
Misure vasca	810 x 400 mm
Profondità vasca	220 mm
Piletta automatica Standard	3 1/2"
Base	900 mm



Soprato

Filoto

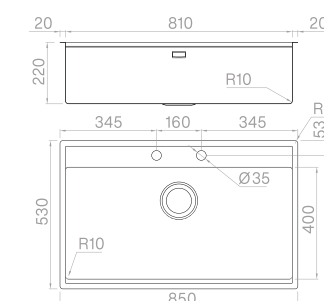
Cod. **ALGI81**Cod. **ALGG81**

Accessori a pag. 179

NEWGO 70

READY



Griglia
Vaschetta inclinata forata
Miscelatore Circle

12
23
52



Cod. **SAGI70**
Cod. **SAGG70**

NEWGO 70

PRO



Griglia

12



Cod. **SBGI70**
Cod. **SBGG70**

NEWGO 70

SOLO



Materiale	AISI 304
Finitura	Spazzolato
Raggio interno	Saldato 10 mm
Misure esterne	740 x 530 mm
Misure vasca	700 x 400 mm
Profondità vasca	220 mm
Piletta automatica Standard	3 ½"
Base	800 mm



Cod. **ALGI70**
Cod. **ALGG70**

Accessori a pag. 179

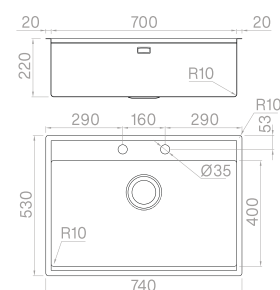

Tagliere in legno rovere

3

300x420x20 mm
Cod. **TRIB3042**



Tagliere in PaperStone®

73

200x420x20 mm
Cod. **TRPS2042**



Tagliere in PaperStone®

54

300x420x20 mm
Cod. **TRPS3042**



Griglia

12

300x420x25 mm
Cod. **GRS2542**



Vaschetta forata

16

190x420x60 mm
Cod. **VQSF2142**



Vaschetta inclinata forata

23

300x420x110/60 mm
Cod. **VQSI2842**



Vaschetta

26

300x420x160 mm
Cod. **VQSP2842**



Vaschetta porta piatti

53

300x420x60 mm
Cod. **VQSF2842**



Goggiolatoio

61

340x420x30 mm
Cod. **VQSI3442**



Set grattugie PaperStone®

75

200x420x80 mm
Cod. **TI2442GP**



TITANIUM

Lo speciale trattamento PVD valorizza l'acciaio inossidabile con una lucentezza profonda e tonalità sofisticate. Questa tecnologia avanzata conferisce all'acciaio un ruolo da autentico elemento di stile, ideale per ambienti che richiedono esclusività e carattere.

Proposta nelle tre finiture esclusive ARTINOX Gun Metal, Copper Bronze e Pale Gold, TITANIUM esprime un'eleganza distintiva, sostenuta da prestazioni superiori come l'aumento della durezza superficiale e una maggiore resistenza alla corrosione. Questa collezione è completata da accessori e miscelatori coordinati nelle stesse tonalità.



TITANIUM GUN METAL



TITANIUM 70 GUN METAL

READY

Vaschetta forata Gun Metal
Miscelatore Vitra

17
42

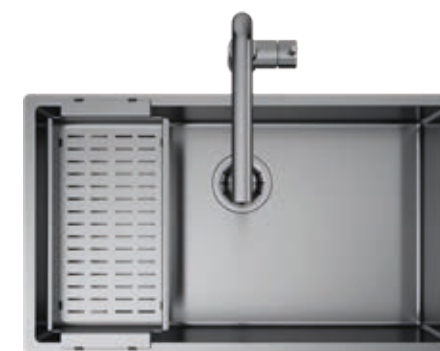

 Sopratop
 Filotop
 Sottotop

Cod. **SATI70RA**
 Cod. **SATG70RA**
 Cod. **SATO70RA**

TITANIUM 70 GUN METAL

PRO

Vaschetta forata Gun Metal

17





 Sopratop
 Filotop
 Sottotop

Cod. **SBTI70RA**
 Cod. **SBTG70RA**
 Cod. **SBTO70RA**

TITANIUM 70 GUN METAL

SOLO



Materiale	AISI 304
Finitura	PVD Gun Metal
Raggio interno	Saldato 10 mm
Misure esterne	740 x 440 mm
Misure vasca	700 x 400 mm
Profondità vasca	200 mm
Piletta Plus Gun Metal	3 1/2"
Base	800 mm
 Sopratop	Cod. TI7040RA
 Filotop	Cod. TG7040RA
 Sottotop	Cod. TO7040RA

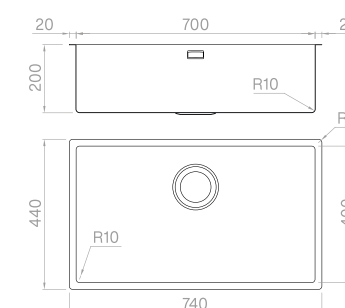

Accessori a pag. 185

TITANIUM 50 GUN METAL

READY



Vaschetta forata Gun Metal
Miscelatore Vitra

17
42

— Sopratop
— Filotop
— Sottotop

Cod. **SATI50RA**
Cod. **SATG50RA**
Cod. **SATO50RA**

TITANIUM 50 GUN METAL

PRO



Vaschetta forata Gun Metal

17

— Sopratop
— Filotop
— Sottotop

Cod. **SBTI50RA**
Cod. **SBTG50RA**
Cod. **SBTO50RA**

TITANIUM 50 GUN METAL

SOLO



Materiale	AISI 304
Finitura	PVD Gun Metal
Raggio interno	Saldato 10 mm
Misure esterne	540 x 440 mm
Misure vasca	500 x 400 mm
Profondità vasca	200 mm
Piletta Plus Gun Metal	3 ½"
Base	600 mm

— Sopratop
— Filotop
— Sottotop

Cod. **TI5040RA**
Cod. **TG5040RA**
Cod. **TO5040RA**

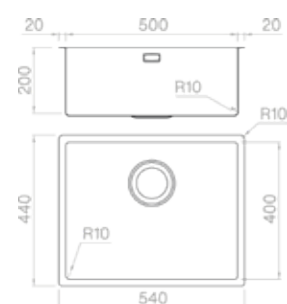

Accessori a pag. 185

Tagliere in legno rovere

3

300x420x20 mm
Cod. **TRIB3042**



Set grattugie PaperStone®

75

200x420x80 mm
Cod. **TI2442GP**



Tagliere in PaperStone®

73

200x420x20 mm
Cod. **TRPS2042**



Vaschetta forata Gun Metal

17

210x420x60 mm
Cod. **VQAF2142**

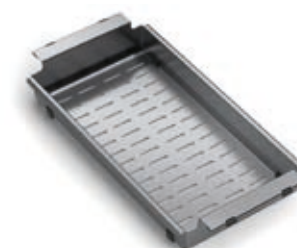

TITANIUM COPPER BRONZE



TITANIUM 70 COPPER BRONZE

READY

Vaschetta forata Copper Bronze

18

Miscelatore Vitra

43

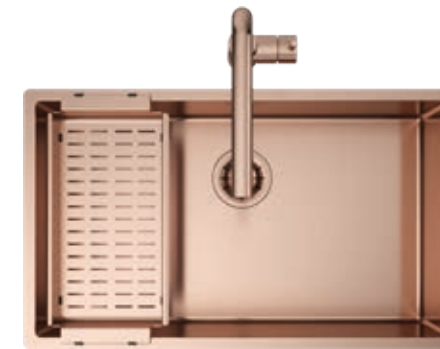

-  Sopratop
-  Filotop
-  Sottotop

Cod. **SATI70RC**Cod. **SATG70RC**Cod. **SATO70RC**

TITANIUM 70 COPPER BRONZE

PRO

Vaschetta forata Copper Bronze

18



-  Sopratop
-  Filotop
-  Sottotop

Cod. **SBTI70RC**Cod. **SBTG70RC**Cod. **SBTO70RC**

TITANIUM 70 COPPER BRONZE

SOLO



Materiale	AISI 304
Finitura	PVD Copper Bronze
Raggio interno	Saldato 10 mm
Misure esterne	740 x 440 mm
Misure vasca	700 x 400 mm
Profondità vasca	200 mm
Piletta Plus Copper Bronze	3 1/2"
Base	800 mm
 Sopratop	Cod. TI7040RC
 Filotop	Cod. TG7040RC
 Sottotop	Cod. TO7040RC

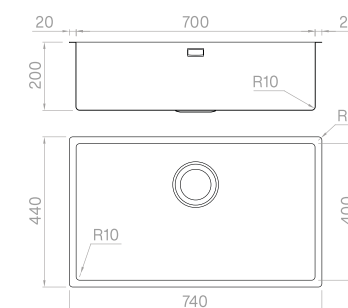

Accessori a pag. 189

TITANIUM 50 COPPER BRONZE

READY



Vaschetta forata Copper Bronze
Miscelatore Vitra

18

43

Cod. **SAT150RC**Cod. **SATG50RC**Cod. **SAT050RC**

TITANIUM 50 COPPER BRONZE

PRO



Vaschetta forata Copper Bronze

18

Cod. **SBT150RC**Cod. **SBTG50RC**Cod. **SBT050RC**

TITANIUM 50 COPPER BRONZE

SOLO



Materiale	AISI 304
Finitura	PVD Copper Bronze
Raggio interno	Saldato 10 mm
Misure esterne	540 x 440 mm
Misure vasca	500 x 400 mm
Profondità vasca	200 mm
Piletta Plus Copper Bronze	3 ½"
Base	600 mm

Cod. **T15040RC**Cod. **TG5040RC**Cod. **T05040RC**

Accessori a pag. 189

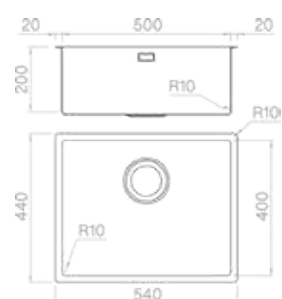

Tagliere in legno rovere

3

300x420x20 mm

Cod. **TRIB3042**

Set grattugie PaperStone®

75

200x420x80 mm

Cod. **T12442GP**

Tagliere in PaperStone®

73

200x420x20 mm

Cod. **TRPS2042**

Vaschetta forata Copper Bronze

18

210x420x60 mm

Cod. **VQCF 2142**

TITANIUM PALE GOLD



TITANIUM 70 PALE GOLD

READY

Vaschetta forata Pale Gold
Miscelatore Vitra

19

44

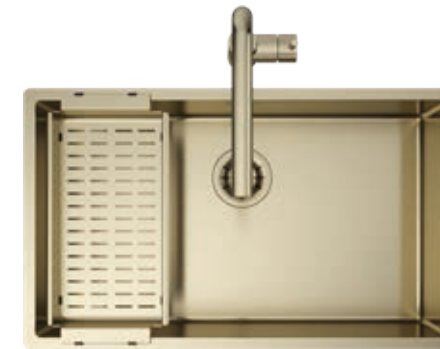

 Sopratop
 Filotop
 Sottotop

Cod. **SATI70RG**Cod. **SATG70RG**Cod. **SAT070RG**

TITANIUM 70 PALE GOLD

PRO

Vaschetta forata Pale Gold

19



 Sopratop
 Filotop
 Sottotop

Cod. **SBTI70RG**Cod. **SBTG70RG**Cod. **SBT070RG**

TITANIUM 70 PALE GOLD

SOLO

Materiale	AISI 304
Finitura	PVD Pale Gold
Raggio interno	Saldato 10 mm
Misure esterne	740 x 440 mm
Misure vasca	700 x 400 mm
Profondità vasca	200 mm
Piletta Plus Pale Gold	3 1/2"
Base	800 mm
 Sopratop	Cod. TI7040RG
 Filotop	Cod. TG7040RG
 Sottotop	Cod. T07040RG

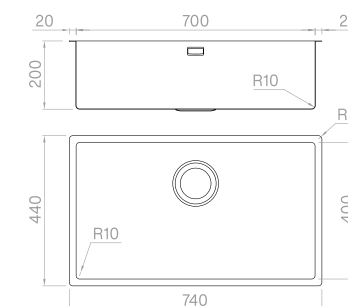

Accessori a pag. 193

TITANIUM 50 PALE GOLD

READY



Vaschetta forata Pale Gold
Miscelatore Vitra

19
44

 Sopratop
 Filotop
 Sottotop

Cod. **SATI50RG**
 Cod. **SATG50RG**
 Cod. **SAT050RG**

TITANIUM 50 PALE GOLD

PRO



Vaschetta forata Pale Gold

19

 Sopratop
 Filotop
 Sottotop

Cod. **SBTI50RG**
 Cod. **SBTG50RG**
 Cod. **SBT050RG**

TITANIUM 50 PALE GOLD

SOLO



Materiale	AISI 304
Finitura	PVD Pale Gold
Raggio interno	Saldato 10 mm
Misure esterne	540 x 440 mm
Misure vasca	500 x 400 mm
Profondità vasca	200 mm
Piletta Plus Pale Gold	3 ½"
Base	600 mm

 Sopratop
 Filotop
 Sottotop

Cod. **TI5040RG**
 Cod. **TG5040RG**
 Cod. **T05040RG**

Accessori a pag. 193

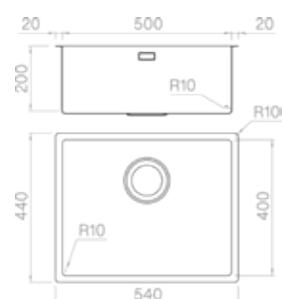

Tagliere in legno rovere

3

300x420x20 mm
Cod. **TRIB3042**



Set grattugie PaperStone®

75

200x420x80 mm
Cod. **T12442GP**



Tagliere in PaperStone®

73

200x420x20 mm
Cod. **TRPS2042**



Vaschetta forata Pale Gold

19

210x420x60 mm
Cod. **VQGF2142**

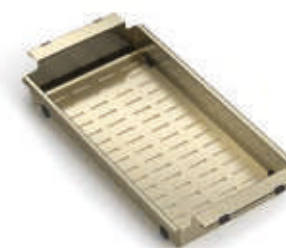

PRISMA

Un perfetto connubio tra pulizia formale e precisione geometrica. Essenziale nelle pareti perimetrali, si evolve in un esclusivo fondo a diamante con perimetro inclinato. Questa forma conferisce un carattere distintivo, trasformando PRISMA in un elemento raffinato e armonioso, pensato per arricchire ogni ambiente cucina con sobria eleganza.



PRISMA 81

READY

Tagliere in legno
Vaschetta forata
Miscelatore Eos

3
16
39



 Sopratop
 Filotop
 Sottotop

Cod. **SAPRI81**
 Cod. **SAPRG81**
 Cod. **SAPRO81**

PRISMA 81

PRO

Vaschetta forata

16



 Sopratop
 Filotop
 Sottotop

Cod. **SBPRI81**
 Cod. **SBPRG81**
 Cod. **SBPRO81**

PRISMA 81

SOLO

Materiale	AISI 304
Finitura	Spazzolato
Raggio interno	Saldato 0 mm
Misure esterne	850 x 440 mm
Misure vasca	810 x 400 mm
Profondità vasca	200 mm
Piletta standard	3 1/2"
Base	900 mm



 Sopratop
 Filotop
 Sottotop

Cod. **PRI81**
 Cod. **PRG81**
 Cod. **PRO81**

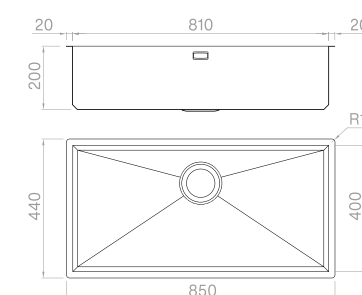

Accessori a pag. 203

PRISMA 70 READY



Tagliere in legno
Vaschetta forata
Miscelatore Eos

3
16
39

— Sopratop
— Filotop
— Sottotop

Cod. **SAPRI70**
Cod. **SAPRG70**
Cod. **SAPR070**

PRISMA 65 READY



Tagliere in legno
Vaschetta forata
Miscelatore Eos

3
16
39

— Sopratop
— Filotop
— Sottotop

Cod. **SAPRI65**
Cod. **SAPRG65**
Cod. **SAPR065**

PRISMA 70 PRO



Vaschetta forata

16

— Sopratop
— Filotop
— Sottotop

Cod. **SBPRI70**
Cod. **SBPRG70**
Cod. **SBPR070**

PRISMA 65 PRO



Vaschetta forata

16

— Sopratop
— Filotop
— Sottotop

Cod. **SBPRI65**
Cod. **SBPRG65**
Cod. **SBPR065**

PRISMA 70 SOLO



Materiale	AISI 304
Finitura	Spazzolato
Raggio interno	Saldato 0 mm
Misure esterne	740 x 440 mm
Misure vasca	700 x 400 mm
Profondità vasca	200 mm
Piletta standard	3 ½"
Base	800 mm

— Sopratop
— Filotop
— Sottotop

Cod. **PRI70**
Cod. **PRG70**
Cod. **PR070**

PRISMA 65 SOLO



Materiale	AISI 304
Finitura	Spazzolato
Raggio interno	Saldato 0 mm
Misure esterne	690 x 440 mm
Misure vasca	650 x 400 mm
Profondità vasca	200 mm
Piletta standard	3 ½"
Base	750 mm

— Sopratop
— Filotop
— Sottotop

Cod. **PRI65**
Cod. **PRG65**
Cod. **PR065**

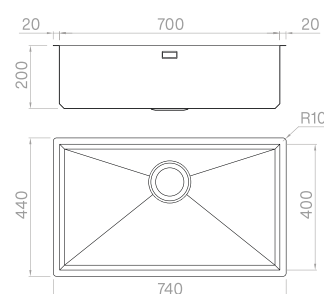

Accessori a pag. 203

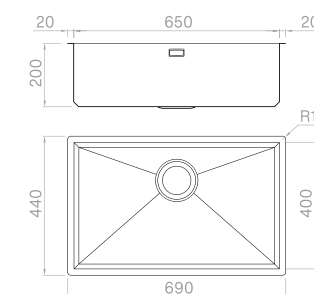

Accessori a pag. 203

PRISMA 50

READY

Vaschetta forata
Miscelatore Eidos

16
46



Cod. **SAPRI50**
Cod. **SAPRG50**
Cod. **SAPRO50**

PRISMA 50

PRO

Vaschetta forata

16



Cod. **SBPRI50**
Cod. **SBPRG50**
Cod. **SBPRO50**

PRISMA 50

SOLO

Materiale	AISI 304
Finitura	Spazzolato
Raggio interno	Saldato 0 mm
Misure esterne	540 x 440 mm
Misure vasca	500 x 400 mm
Profondità vasca	200 mm
Piletta standard	3 ½"
Base	600 mm

Cod. **PRI50**
 Cod. **PRG50**
 Cod. **PRO50**

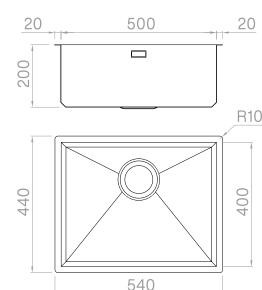

Accessori a pag. 203

PRISMA 45

READY

Vaschetta forata
Miscelatore Eidos

16
46



Cod. **SAPRI45**
Cod. **SAPRG45**
Cod. **SAPRO45**

PRISMA 45

PRO

Vaschetta forata

16



Cod. **SBPRI45**
Cod. **SBPRG45**
Cod. **SBPRO45**

PRISMA 45

SOLO

Materiale	AISI 304
Finitura	Spazzolato
Raggio interno	Saldato 0 mm
Misure esterne	490 x 440 mm
Misure vasca	450 x 400 mm
Profondità vasca	200 mm
Piletta standard	3 ½"
Base	600 mm

Cod. **PRI45**
 Cod. **PRG45**
 Cod. **PRO45**

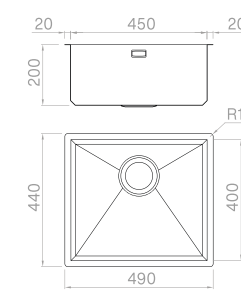

Accessori a pag. 203

PRISMA 40

READY

Vaschetta forata
Miscelatore Eidos

16
46



Cod. **SAPRI40**
Cod. **SAPRG40**
Cod. **SAPRO40**

PRISMA 40

PRO

Vaschetta forata

16



Cod. **SBPRI40**
Cod. **SBPRG40**
Cod. **SBPRO40**

PRISMA 40

SOLO

Materiale	AISI 304
Finitura	Spazzolato
Raggio interno	Saldato 0 mm
Misure esterne	440 x 440 mm
Misure vasca	400 x 400 mm
Profondità vasca	200 mm
Piletta standard	3 ½"
Base	600 mm



Cod. **PRI40**
Cod. **PRG40**
Cod. **PRO40**

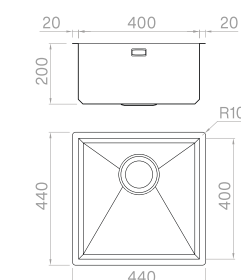

Accessori a pag. 203

PRISMA 34

READY

Vaschetta forata
Miscelatore Eidos

16
46



Cod. **SAPRI34**
Cod. **SAPRG34**
Cod. **SAPRO34**

PRISMA 34

PRO

Vaschetta forata

16



Cod. **SBPRI34**
Cod. **SBPRG34**
Cod. **SBPRO34**

PRISMA 34

SOLO

Materiale	AISI 304
Finitura	Spazzolato
Raggio interno	Saldato 0 mm
Misure esterne	380 x 440 mm
Misure vasca	340 x 400 mm
Profondità vasca	200 mm
Piletta standard	3 ½"
Base	450 mm



Cod. **PRI34**
Cod. **PRG34**
Cod. **PRO34**

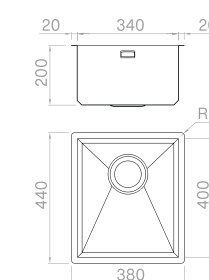

Accessori a pag. 203

**Tagliere in legno rovere****3**

300x420x20 mm

Cod. **TRIB3042****Tagliere in PaperStone®****73**

200x420x20 mm

Cod. **TRPS2042****Tagliere in PaperStone®****54**

300x420x20 mm

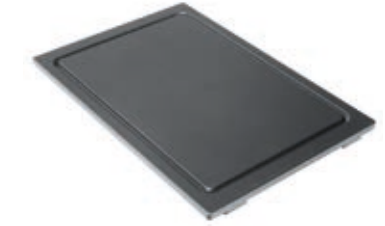
Cod. **TRPS3042****Griglia****12**

300x420x25 mm

Cod. **GRS2542****Vaschetta forata****16**

190x420x60 mm

Cod. **VQSF2142****Vaschetta inclinata forata****23**

300x420x110/60 mm

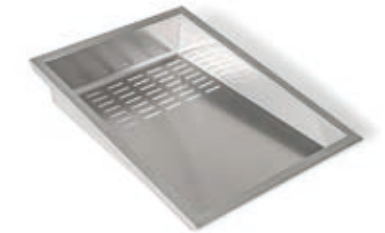
Cod. **VQSI2842****Vaschetta****26**

300x420x160 mm

Cod. **VQSP2842****Vaschetta porta piatti****53**

300x420x60 mm

Cod. **VQSF2842****Goggiolatoio****61**

340x420x30 mm

Cod. **VQSI3442****Set grattugie PaperStone®****75**

200x420x80 mm

Cod. **TI24426P**



OUTDOOR

STARTAC MARINA

Visibile e invisibile, ridefinisce lo spazio cucina, con eleganza indoor e resistenza outdoor. Il raffinato sportello di chiusura, anche rivestito con la finitura del piano, conferisce unicità integrarsi perfettamente nella cucina. L'area operativa appare e scompare con naturalezza, fondendosi con lo stile e l'atmosfera dell'ambiente. Realizzata in acciaio marino, questa soluzione garantisce la più alta resistenza in ambienti salini.





STARTAC MARINA 55

READY

Vaschetta forata
Miscelatore Circle

58
52



 Sopratop

Cod. **SAMC55**

STARTAC MARINA 55

PRO

Miscelatore Circle

52



 Sopratop

Cod. **SBMC55**



STARTAC MARINA 55

SOLO

Materiale	AISI 316 L
Finitura	Spazzolato
Raggio interno	Saldato 10 mm
Misure esterne	590 x 510 mm
Misure vasca	550 x 350 mm
Profondità vasca	245 mm
Piletta Standard	3 1/2"
Base	600 mm



 Sopratop
 Sottotop

Cod. **MC55**
Cod. **MC55G**

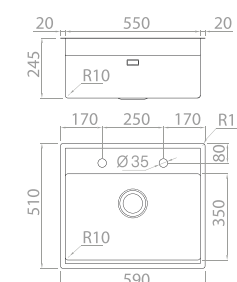

Accessori a pag. 218

GHOST MARINA

Design, comfort, igiene e praticità in ogni utilizzo. Realizzata in acciaio marino AISI 316L, GHOST MARINA è la soluzione ideale per spazi contenuti, portando innovazione e funzionalità negli ambienti outdoor. Il ribassamento interno permette di integrare il miscelatore abbattibile, anch'esso in acciaio marino, creando una zona operativa estremamente funzionale che può scomparire completamente alla vista, per un effetto armonioso e discreto.



GHOST MARINA 60

READY

Tagliere PaperStone®
Miscelatore Circle

73

52



 Sopratop
 Sottotop

Cod. **SAG060MG**

Cod. **SAGS60MG**

GHOST MARINA 60

PRO

Miscelatore Circle

52



 Sopratop
 Sottotop

Cod. **SBG060MG**

Cod. **SBGS60MG**

GHOST MARINA 60

SOLO

Materiale	AISI 316 L
Finitura	Spazzolato
Raggio interno	Saldato 10 mm
Misure esterne	440 x 520 mm
Misure vasca	400 x 400 + 80 mm
Profondità vasca	65 / 200 mm
Piletta Plus	3 ½"
Base	600 mm



 Sopratop
 Sottotop

Cod. **SIG60MG**

Cod. **SSG60MG**

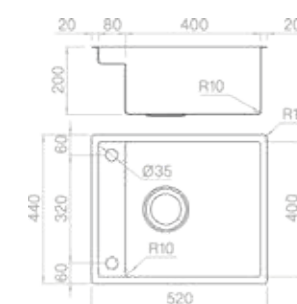

Accessori a pag. 218

RADIUS MARINA

La collezione è realizzata in acciaio marino AISI 316L, un materiale nobile di altissima qualità che garantisce eccellente resistenza alla corrosione e all'ossidazione. Questa peculiarità rende RADIUS MARINA particolarmente adatta agli ambienti esterni, in particolare in contesti marini, unendo durata, funzionalità ed eleganza senza compromessi.



RADIUS MARINA 70

READY



Tagliere PaperStone®
 Vaschetta forata
 Miscelatore Circle

73
 50
 52

— Sopratop
 — Filotop
 — Sottotop

Cod. **SABI70MR**
 Cod. **SABG70MR**
 Cod. **SABO70MR**

RADIUS MARINA 70

PRO



Vaschetta forata

50

— Sopratop
 — Filotop
 — Sottotop

Cod. **SBBI70MR**
 Cod. **SBBG70MR**
 Cod. **SBBO70MR**

RADIUS MARINA 70

SOLO



Materiale	AISI 316 L
Finitura	Spazzolato
Raggio interno	Saldato 10 mm
Misure esterne	740 x 530 mm
Misure vasca	700 x 400 mm
Profondità vasca	220 mm
Piletta standard	3 ½"
Base	800 mm

— Sopratop
 — Filotop
 — Sottotop

Cod. **B17040MR**
 Cod. **BG7040MR**
 Cod. **B07040MR**

Accessori a pag. 218

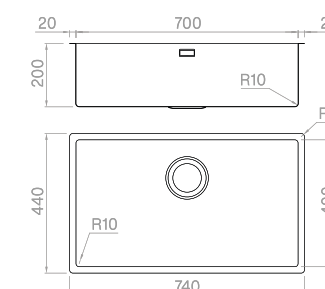

RADIUS MARINA 50

READY



Tagliere PaperStone®
Vaschetta forata
Miscelatore Circle

73
50
52

— Sopratop
— Filotop
— Sottotop

Cod. **SABI50MR**
Cod. **SABG50MR**
Cod. **SABO50MR**

RADIUS MARINA 50

PRO



Tagliere PaperStone®

73

— Sopratop
— Filotop
— Sottotop

Cod. **SBBI50MR**
Cod. **SBBG50MR**
Cod. **SBBO50MR**

RADIUS MARINA 50

SOLO



Materiale	AISI 316 L
Finitura	Spazzolato
Raggio interno	Saldato 10 mm
Misure esterne	540 x 440 mm
Misure vasca	500 x 400 mm
Profondità vasca	200 mm
Piletta standard	3 ½"
Base	600 mm

— Sopratop
— Filotop
— Sottotop

Cod. **BI5040MR**
Cod. **BG5040MR**
Cod. **BO5040MR**

Accessori a pag. 218

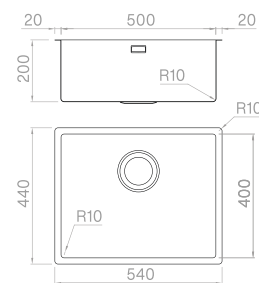

RADIUS MARINA 45

READY



Tagliere PaperStone®
Vaschetta forata
Miscelatore Circle

73
50
52

— Sopratop
— Filotop
— Sottotop

Cod. **SABI45MR**
Cod. **SABG45MR**
Cod. **SABO45MR**

RADIUS MARINA 45

PRO



Tagliere PaperStone®

73

— Sopratop
— Filotop
— Sottotop

Cod. **SBBI45MR**
Cod. **SBBG45MR**
Cod. **SBBO45MR**

RADIUS MARINA 45

SOLO



Materiale	AISI 316 L
Finitura	Spazzolato
Raggio interno	Saldato 10 mm
Misure esterne	490 x 440 mm
Misure vasca	450 x 400 mm
Profondità vasca	200 mm
Piletta standard	3 ½"
Base	600 mm

— Sopratop
— Filotop
— Sottotop

Cod. **BI4540MR**
Cod. **BG4540MR**
Cod. **BO4540MR**

Accessori a pag. 218

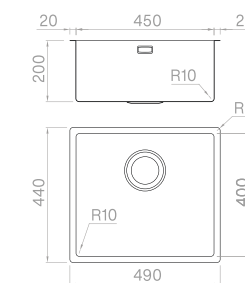

RADIUS MARINA 40

READY

Tagliere PaperStone®
Miscelatore Circle

73
52



- Sopratop
- Filotop
- Sottotop

Cod. **SABI40MR**
Cod. **SABG40MR**
Cod. **SABO40MR**

RADIUS MARINA 40

PRO

Tagliere PaperStone®

73



- Sopratop
- Filotop
- Sottotop

Cod. **SBBI40MR**
Cod. **SBBG40MR**
Cod. **SBBO40MR**

RADIUS MARINA 40

SOLO

Materiale	AISI 316 L
Finitura	Spazzolato
Raggio interno	Saldato 10 mm
Misure esterne	440 x 440 mm
Misure vasca	400 x 400 mm
Profondità vasca	200 mm
Piletta standard	3 ½"
Base	600 mm

- Sopratop Cod. **BI4040MR**
- Filotop Cod. **BG4040MR**
- Sottotop Cod. **BO4040MR**

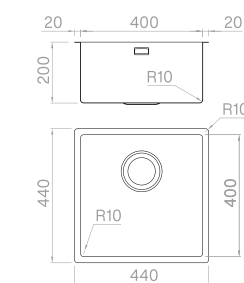

Accessori a pag. 218

RADIUS MARINA 34

READY

Tagliere PaperStone®
Miscelatore Circle

73
52



- Sopratop
- Filotop
- Sottotop

Cod. **SABI34MR**
Cod. **SABG34MR**
Cod. **SABO34MR**

RADIUS MARINA 34

PRO

Tagliere PaperStone®

73



- Sopratop
- Filotop
- Sottotop

Cod. **SBBI34MR**
Cod. **SBBG34MR**
Cod. **SBBO34MR**

RADIUS MARINA 34

SOLO

Materiale	AISI 316 L
Finitura	Spazzolato
Raggio interno	Saldato 10 mm
Misure esterne	380 x 440 mm
Misure vasca	340 x 400 mm
Profondità vasca	200 mm
Piletta standard	3 ½"
Base	450 mm

- Sopratop Cod. **BI3440MR**
- Filotop Cod. **BG3440MR**
- Sottotop Cod. **BO3440MR**

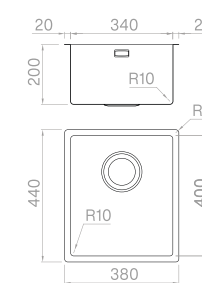

Accessori a pag. 218

RADIUS MARINA 18

SOLO



Materiale	AISI 316 L
Finitura	Spazzolato
Raggio interno	Saldato 10 mm
Misure esterne	220 x 440 mm
Misure vasca	180 x 400 mm
Profondità vasca	170 mm
Piletta standard	3 ½"
Base	300 mm

-  Sopratop
-  Filotop
-  Sottotop

Cod. **BI1840MR**

Cod. **BG1840MR**

Cod. **BO1840MR**

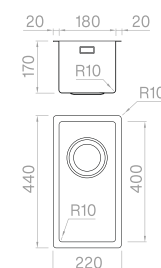

ACCESSORI DEDICATI

Tagliere PaperStone®

54

300x420x20 mm
Cod. **TRPS3042**



Tagliere PaperStone®

73

200x420x20 mm
Cod. **TRPS2042**



Set grattugie PaperStone®

75

200x420x80 mm
Cod. **TI24426P**



Vaschetta forata

50

190x420x60 mm
Cod. **VQMF2142**



Vaschetta inclinata forata

51

300x420x80/40 mm
Cod. **VQMI2842**

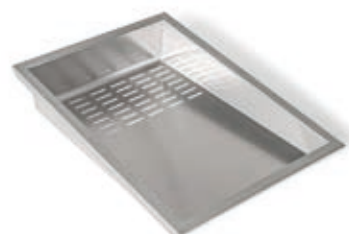

Vaschetta forata

58

190x375x60 mm
Cod. **VQMF2137**



Interamente progettati da noi e realizzati in Italia, i nostri miscelatori rappresentano l'incontro perfetto tra design esclusivo, funzionalità e alla massima qualità costruttiva. Ogni componente è studiato nei minimi dettagli e realizzato in Italia ed in acciaio inossidabile marino AISI 316L, il materiale nobile che garantisce durata, resistenza alla corrosione e alle aggressioni esterne. Il risultato è una gamma unica, capace di unire estetica raffinata e affidabilità senza compromessi, concepita per completare con eleganza qualsiasi ambiente cucina, indoor o outdoor, con lo stile distintivo Artinox.



MISCELATORI



THERION

38

Materiale	Acciaio inox AISI 316 L
Finitura	Spazzolato
Rotazione canna	120°
Foro installazione	Ø 35 mm
Cartuccia	disco ceramico
Doccetta	estraibile, doppio getto

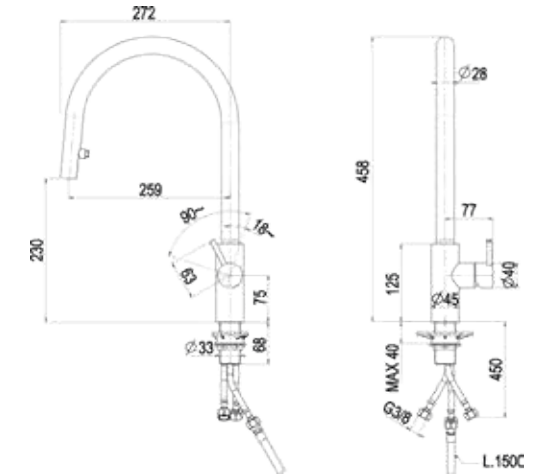
Cod. **SS03064**

EOS

39

Materiale	Acciaio inox AISI 316 L
Rotazione canna	120°
Foro installazione	Ø 35 mm
Cartuccia	disco ceramico
Doccetta	estraibile

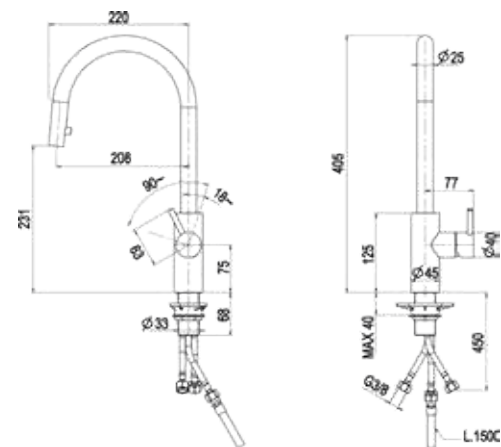
Cod. **SS03091**

ARION

59

Materiale	Acciaio inox AISI 316 L
Finitura	Spazzolato
Rotazione canna	120°
Foro installazione	Ø 35 mm
Cartuccia	disco ceramico
Doccetta	estraibile

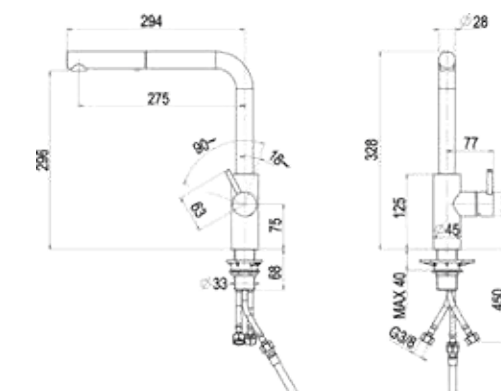
Cod. **SS03063**

LYMPIA 3 VIE

41

Materiale	Acciaio inox AISI 316 L
Rotazione canna	360°
Foro installazione	Ø 35 mm
Cartuccia	disco ceramico

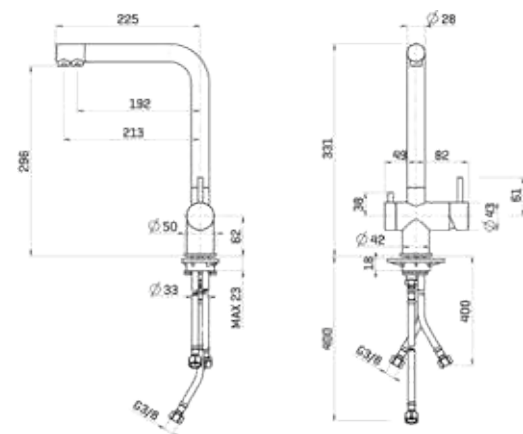

Testata e cartuccia pag. 236

Cod. **SS03094**

CIRCLE

52

Materiale	Acciaio inox AISI 316 L
Finitura	Spazzolato
Rotazione canna	360°
Foro installazione	Ø 35 mm
Cartuccia	disco ceramico
Doccetta	estraibile

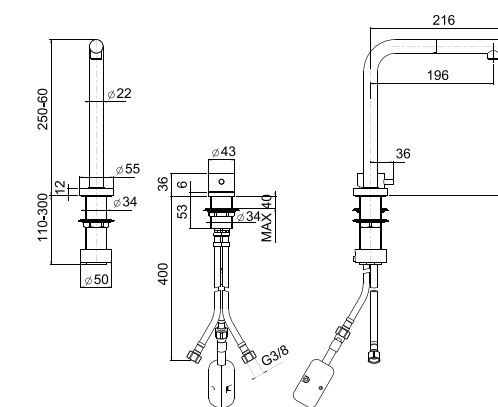
Cod. **SS02802**

EIDOS

46

Materiale	Acciaio inox AISI 316L
Finitura	Spazzolato
Rotazione canna	360°
Foro installazione	Ø 35 mm
Cartuccia	disco ceramico

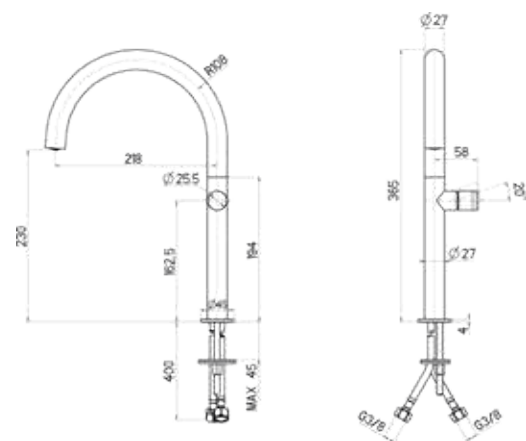
Cod. **SS03093**

DISPENSER

45

Finitura	Acciaio inox AISI 304
Rotazione canna	360°
Foro installazione	Ø 35 mm
Cartuccia	disco ceramico
Doccetta	estraibile

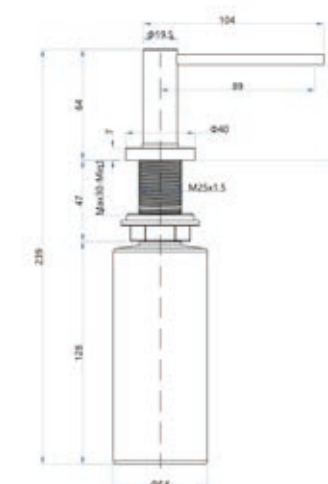
Cod. **SS03114**

VITRA GUN METAL

42

Materiale	PVD Gun Metal
Finitura	Acciaio inox AISI 304
Rotazione canna	120°
Foro installazione	Ø 35 mm
Cartuccia	disco ceramico
Doccetta	estraibile

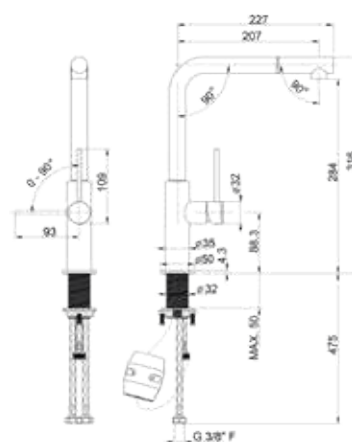
Cod. **SS03124**

VITRA COPPER BRONZE

43

Materiale	PVD Copper Bronze
Finitura	Acciaio inox AISI 304
Rotazione canna	120°
Foro installazione	Ø 35 mm
Cartuccia	disco ceramico
Doccetta	estraibile

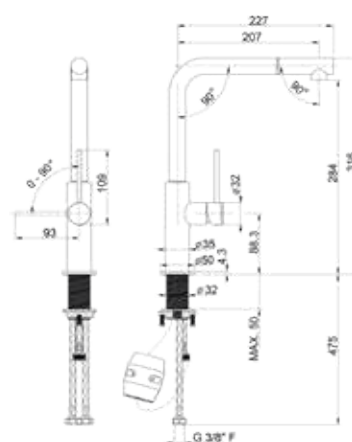
Cod. **SS03126**

VITRA PALE GOLD

44

Materiale	PVD Pale Gold
Finitura	Acciaio inox AISI 304
Rotazione canna	120°
Foro installazione	Ø 35 mm
Cartuccia	disco ceramico
Doccetta	estraibile

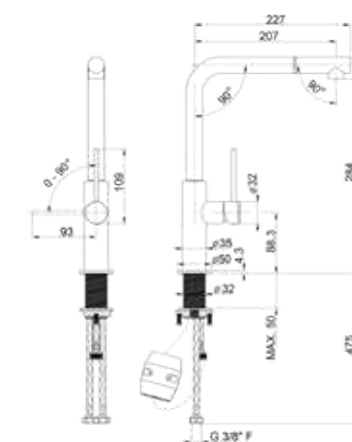
Cod. **SS03125**

COMPLEMENTI

PILETTE, TROPPOPIENI E SIFONI



PLUS – SATINATO
Cod. **SS02608**

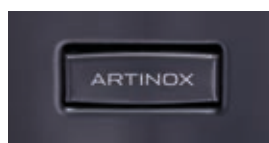

PLUS – GUN METAL
Cod. **SS02717**



STANDARD – SATINATO
Cod. **SS02740**

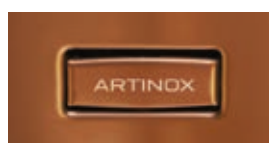

PLUS – COPPER BRONZE
Cod. **SS02716**



ECLISSE – SATINATO
Permette il deflusso.
Compatibile con pilette tonde ø 3,5".

Cod. **SS02748**



PLUS – PALE GOLD
Cod. **SS02715**



SIFONE 1 VIA
Cod. **SS00448**

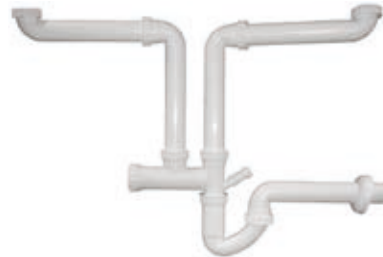

SIFONE 2 VIE
Cod. **SS00449**

PILETTE AUTOMATICHE



SALTARELLO – PLUS
Azionamento a pressione.
Cestello e pulsante comando satinati.
Cod. **SS02744**



SALTARELLO – STANDARD
Azionamento a pressione.
Cestello e comando satinati.
Cod. **SS02742**



PILETTE AUTOMATICHE TITANIUM



SALTARELLO – PLUS Gun Metal – Azionamento a pressione.
Cestello e pulsante comando in PVD.
Cod. **SS02747**



SALTARELLO – PLUS Copper Bronze – Azionamento a pressione. Cestello e pulsante comando in PVD.
Cod. **SS02746**



SALTARELLO – PLUS Pale Gold – Azionamento a pressione. Cestello e pulsante comando in PVD.
Cod. **SS02745**



FILTRI ACQUA



TESTATA E CARTUCCIA FILTRO

Cod. **SS03135**



CARTUCCIA E FILTRO 0,5μ

Cod. **SS03116**

CURA DELL'ACCIAIO INOX



PULIZIA - KIT COMPLETO

- Crema detergente (flacone da 250 ml)
- Panno per pulizia
- Panno di finitura

Cod. **SS01751**
Cod. **SS02771** [6 Conf.]



CREMA DETERGENTE

Specifica per la pulizia dell'acciaio inox - flacone da 250 ml.

Cod. **SS02772** [12 Pz.]



PANNO ANTIBATTERICO

In microfibra per finiture - dimensione 40x40 cm.
Confezione da 3 pezzi.

Cod. **SS02773**

I lavelli workstation di ARTINOX sono realizzati in acciaio inox AISI 304 18/10 (EN 1.4301), una lega di acciaio al cromo e nichel. L'acciaio inox è il materiale igienico per eccellenza, tenace e molto resistente alla corrosione, il prodotto ideale per il contatto con gli alimenti. Tutti gli articoli ARTINOX sono realizzati rispettando i più severi standard qualitativi e testati uno ad uno.

AVVERTENZE

Come tutti i materiali anche l'acciaio inox richiede una cura regolare ed una pulizia quotidiana. L'uso improprio può danneggiare la superficie anche in modo permanente.

I seguenti consigli proteggono il lavello dai danni causati dalla corrosione di detersivi non idonei alla pulizia.

PULIZIA

Per la pulizia quotidiana consigliamo di strizzare una spugna dall'acqua calda e bagnarla con aceto bianco. Per una pulizia profonda utilizzare SOLO prodotti ufficiali Artinox, acquistabili presso i rivenditori autorizzati o consultando www.artinox.com.

MANTENIMENTO

Dopo ogni uso, pulire, risciacquare ed asciugare accuratamente il lavello con un panno morbido. NON lasciare detersivi e prodotti per la pulizia a lungo a contatto con la superficie. NON utilizzare acido cloridrico, acido fluoridrico, acido fosforico, candeggina, ammoniaca, o detersivi che contengono anche minime dosi tali sostanze. NON utilizzare spugne, detersivi e creme abrasive. NON lasciare oggetti, metalli ferrosi e non ferrosi all'interno del lavello.



CONDIZIONI GENERALI DI VENDITA

Come ordinare:

Si accettano solo ordini scritti e completi. L'ordine dovrà indicare i codici delle singole parti come nel presente listino indicati. Seguirà nostra conferma d'ordine che si intende corretta ed accettata se non contestata entro 3 giorni dalla data di invio a mezzo posta elettronica, fax. La società Artinox S.p.A. si riserva la facoltà, qualora si rendesse opportuno, di variare, modificare e/o annullare, i prodotti, le misure, le descrizioni, i prezzi indicati sul presente listino in qualsiasi momento senza bisogno di alcun preavviso e ciò senza possibilità di rivendicazioni da parte dell'acquirente.

Consegna:

I termini di consegna sono indicativi e si intendono in condizioni normali di lavoro e sono presso l'Artinox. In nessun caso potrà essere richiesto alla venditrice il rimborso per eventuali danni per ritardata consegna, né il ritardo può costituire motivo di rescissione del contratto. L'acquirente ha infatti rinunciato a far valere ogni domanda, azione ed eccezione in ordine a tali ipotesi. La verifica della qualità e del tipo di merce deve essere fatta dal compratore alla consegna.

Resa:

franco nostro stabilimento di Conegliano (Treviso) Italia. La merce viaggia a rischio e pericolo dell'acquirente anche nei casi in cui il prodotto, per accordi diversi, sia reso franco destino.

Imballo:

Imballo standard in scatole di cartone gratuite o con imballo adeguato è compreso nel prezzo. Imballi speciali verranno addebitati al costo.

Prezzi:

I prezzi del presente listino non comprendono: i.v.a., trasporto, imballi speciali, oneri doganali, gabbie e/o bancali in legno, montaggio e collaudo.

Condizioni di pagamento:

Da convenire. Tutti gli oneri relativi al pagamento di commissioni bancarie, bolli, ecc. saranno addebitati in fattura. Nel caso di ritardi di pagamenti, l'azienda si riserva il diritto di sospendere la consegna degli ordini in corso, senza obbligo di alcuna comunicazione. Le parti espressamente convengono che l'acquirente acquisterà la proprietà del materiale all'atto del pagamento integrale del prezzo complessivo concordato, oltre gli accessori, ma ne assumerà i rischi dal momento della consegna ex art. 1523 c.c. In seguito alla scadenza dei termini concordati dalle parti per il pagamento del materiale, nessun reclamo riguardante la qualità della merce potrà essere fatto valere, neppure in via d'eccezione, in sede giudiziaria, se regolare pagamento alla quale il reclamo si riferisce non avrà ancora avuto luogo.

Interessi di mora:

Il ritardato pagamento comporta automaticamente, senza pertanto bisogno di particolari diffide, l'addebito degli interessi di mora 1,5% mensile dal giorno successivo di scadenza del pagamento indicato in fattura. Saranno addebitate, inoltre, tutte le spese sostenute per il recupero delle somme dovute.

Garanzia:

La garanzia è di 24 mesi dalla data di spedizione e si intende sulle singole parti. Il venditore non risponde dei danni diretti e/o indiretti provocati dalle e/o alle attrezzature, impianti, persone per uso improprio o colposo delle stesse, per urti, per installazione non corretta, per utilizzazione fuori tolleranza.

Tutti i difetti visivi quali botte, graffi, macchie o rotture devono essere tassativamente segnalati prima dell'installazione e/o utilizzo. Le difettosità riportate sopra saranno escluse dalla garanzia qualora venissero segnalate successivamente all'installazione poiché non riconducibili a difetti di origine.

I pezzi difettosi dovranno essere resi, previa autorizzazione scritta della Artinox, franco stabilimento di Conegliano (Treviso) Italia e saranno sostituiti in garanzia solo dopo verifica. I pezzi riconosciuti difettosi saranno sostituiti e spediti franco destino a mezzo corriere. La garanzia non copre i costi relativi alla sostituzione del pezzo, è valida soltanto nei confronti dell'acquirente originario.

Ogni articolo in questo catalogo è prodotto in conformità alle normative vigenti e alle direttive CE. Tutti i dati riportati non sono vincolanti.

Artinox S.p.a. si riserva la facoltà di apportare modifiche ritenute utili al miglioramento della propria offerta in qualsiasi momento, senza preavviso e declinando ogni responsabilità per eventuali errori o inesattezze.

La riproduzione delle colorazioni a catalogo sono da ritenersi indicative.

Sono vietate le riproduzioni nel suo insieme o in parte del presente catalogo, senza la specifica autorizzazione scritta di Artinox S.p.a.

© Copyright 2026 Artinox S.p.a. - Tutti i diritti riservati.

Edizione 4 - Marzo 2026

CONCEPT

Artinox S.p.A.

GRAPHIC DESIGN & PHOTOGRAPHY

Marta Amistani – Topvisualbeauty.com

PRINT

Grafiche Antiga

Artinox SpA

Via F. Fabbri, 39

z.i. Campidui

31015 Conegliano (TV)

+39 0438 4531

home@artinox.com

artinox-sinks.com

100 %

MADE IN

ITALY

