

# ARTINOX

WORKSTATION SINKS

# WORKSTATION SINKS

# HISTORY AND PASSION

Artinox was founded in 1985 by Mario Zanardo in Conegliano in one of the most important Italian industrial areas known for the stainless steel processing. Dedicated to the high-end kitchen market, all our collections are designed and produced with passion in our factory and distributed all over the world.



# QUALITY AND SUSTAINABILITY

Beyond the intrinsic qualities of the raw material, we are committed to the implementation of our environmental management system. At Artinox we have been using the control of all processes to guarantee the maximum result of the services offered - ISO 9001 certification - and taking care of the factors interacting with the environment - ISO 14001 -.



# FUNCTIONAL DESIGN

At Artinox we revolutionize the time spent in the kitchen. All of the Workstations are integrated into the worktop becoming one. The sliding system allows the positioning and the sliding of infinite accessories dedicated to multiple functions; from grids to supports, from chopping boards to containers, these accessories are made to last and to serve with a simple gesture.



# OUR STAINLESS STEEL

Our stainless steel AISI 304 and AISI 316 it's used in both domestic and professional environments while meeting all industry standards. It's extremely easy to clean thanks to the non-porous surface, which results in a high antibacterial property. Our steel is unalterable over time, is made up of over 70% recycled materials and is 100% recyclable.

Artinox has chosen AISI 316 L for the OUTDOOR collection, a complete range of products dedicated for the outdoors. This stainless steel is a specialty material, typically used in marine and surgical environments. It offers very high resistance to saltiness as well as food acids.







# DETAILS THAT MAKE THE DIFFERENCE

## Dedicated accessories

The stainless steel accessories, always thickly produced in our factories, are dishwasher safe.  
The chopping boards are made of wood or non-toxic polyethylene.

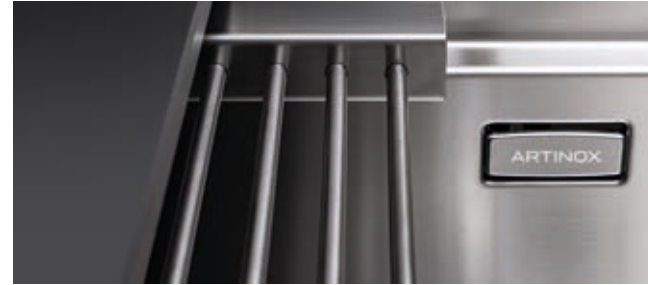

## High thickness steel

We use AISI 304 stainless steel of increased thickness compared to normal market standards, guaranteeing robust products with a unique design.



## Welded products

Artinox produces exclusively Kitchen systems with welding process, 10mm radius corner or zero/45 radius corners.

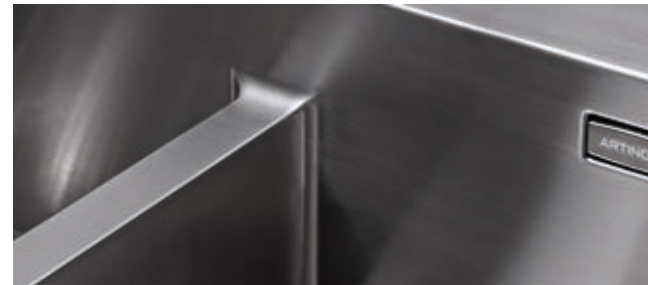

## Generous sizes

Collections are available in various sizes from 170 to 250 depth.  
Large capacity and functionality.



## Holes

All the models in our collections are set up with one or two 35 mm diameter holes for housing the mixer. Additional holes can be requested.



## Pop-up kit

The practical push pop-up kits, combined with the drains system, avoid getting your hands wet in emptying the sink. These are products from selected Italian partners.



## Overflowing system

All products have an integrated back wall overflow and are designed without joints to ensure maximum hygiene.



## Drainage enhanced bottoms

The outflow of the water is guaranteed also by an invitation near the drain and, in specific collections, also by elegant diamond-finished basin bottoms.



## 3 1/2" Drains

The exclusive drains of our models are produced by selected Italian partners. All models, variants and colors are always in stainless steel.



## PaperStone®

PaperStone® is created from recycled paper and a proprietary resin. It is committed to innovative green products that contribute to an environmental sustainability.



# A SET-UP FOR EVERY STYLE

## Over-mount

The over-mount option always allows easy installation on tops of any material.



## Flush-mount

The visible perimeter of the Flush-mount evokes cleanliness, the edge is perfectly rectified with a two tenths of a millimeter tolerance.



## Under-mount

The Under-mount solution allows you to make the most out of the surface of the kitchen countertop.



## Edgeless

The Edgeless installation allows worktop edges to join maximizing the combination between hygiene and aesthetics.

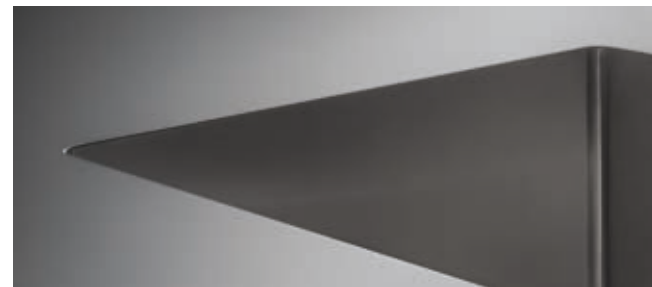

## Integrated

Innovative installation between stainless steel bottom vertically glued and the kitchen countertop.



# INDEX

## WORKSTATIONS

PLANUM	22
LAYER	44

## INTEGRATED

LINEA	74
SHORE	84

## SINKS

TITANIUM	96
RADIUS	110
PRISMA	128
GHOST	140
MOSE	144
NEWGO	152
AQUA	162

## OUTDOOR

STARTAC MARINA	172
GHOST MARINA	178
RADIUS MARINA	180

## ACCESSORY CHANNELS

SINK MIXERS	204
COMPLEMENTS	210
CLEANING PRODUCTS	212
BUSINESS CONDITIONS	214



# WORKSTATIONS

PLANUM



# PLANUM XL

The Planum collection is characterized by large dimensions and a double sliding system, where numerous accessories slide and combine. These features allow to extend the functionality of the work surface, enhancing the overall kitchen experience.



## PLANUM XL 111 READY



- Wooden chopping board **1**
- Slanted colander **23**
- Basin **26**
- Grid **10**
- Loft Tap **38**
- Loft Tap **38**

Top mount

Cod. **SAP I 11**

## PLANUM XL 111 PRO



- Wooden chopping board **1**
- Slanted colander **23**

Top mount

Cod. **SBP I 11**

## PLANUM XL 111 SOLO



- Material AISI 304
- Finishing Brushed
- Inner Corner R 10 mm Welded
- Overall dimensions 1160 x 510 mm
- Basin dimensions 1110 x 400 mm
- Bowl depth 254 mm
- Plus Strainer 3 1/2"
- Cabinet size 1200 mm

Top mount

Cod. **PI 11 4025**

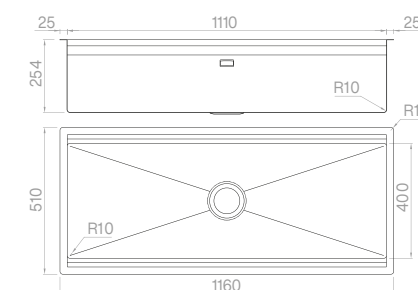

Accessories on page 32

PLANUM XL 81 **READY**



- Wooden chopping board
- Slanted colander
- Grid
- Loft Tap

- 1
- 23
- 10
- 38

Top mount

Cod. **SAP I 81**

PLANUM XL 81 **PRO**



- Wooden chopping board
- Slanted colander

- 1
- 23

Top mount

Cod. **SBP I 81**

PLANUM XL 81 **SOLO**



- |                    |                |
|--------------------|----------------|
| Material           | AISI 304       |
| Finishing          | Brushed        |
| Inner Corner       | R 10 mm Welded |
| Overall dimensions | 860 x 510 mm   |
| Basin dimensions   | 810 x 400 mm   |
| Bowl depth         | 254 mm         |
| Plus Strainer      | 3 ½"           |
| Cabinet size       | 900 mm         |

Top mount

Cod. **PI 81 4025**

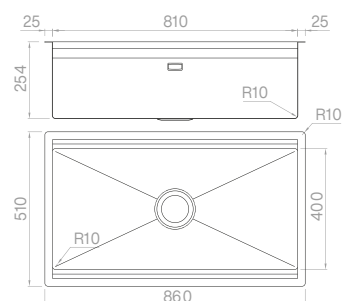

Accessories on page 32

PLANUM XL 70 **READY**



- Wooden chopping board
- Slanted colander
- Grid
- Loft Tap

- 1
- 23
- 10
- 38

Top mount

Cod. **SAP I 70**

PLANUM XL 70 **PRO**



- Wooden chopping board
- Slanted colander

- 1
- 23

Top mount

Cod. **SBP I 70**

PLANUM XL 70 **SOLO**



- |                    |                |
|--------------------|----------------|
| Material           | AISI 304       |
| Finishing          | Brushed        |
| Inner Corner       | R 10 mm Welded |
| Overall dimensions | 750 x 510 mm   |
| Basin dimensions   | 700 x 400 mm   |
| Bowl depth         | 254 mm         |
| Plus Strainer      | 3 ½"           |
| Cabinet size       | 800 mm         |

Top mount

Cod. **PI 70 4025**

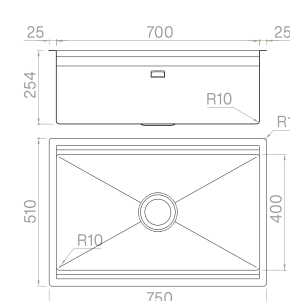

Accessories on page 32

# PLANUM XT

Accessories are housed on two levels inside this discreet workstation. On the upper level, innovative support surfaces made of refined materials slide, while the lower level accommodates containers for draining and containing preparation food.



## PLANUM XT 111

### READY



- Wooden chopping board
- Slanted colander
- Basin
- Grid
- Loft Tap

- 1
- 23
- 26
- 10
- 38

Under mount

Cod. **SAP0 11 XT**

## PLANUM XT 111

### PRO



- Wooden chopping board
- Slanted colander

- 1
- 23

Under mount

Cod. **SBP0 11 XT**

## PLANUM XT 111

### SOLO



- Material AISI 304
- Finishing Brushed
- Inner Corner R 10 mm Welded
- Overall dimensions 1150 x 490 mm
- Basin dimensions 1110 x 400 mm
- Bowl depth 234 mm
- Plus Strainer 3 1/2"
- Cabinet size 1200 mm

Under mount

Cod. **PO 11 XT**

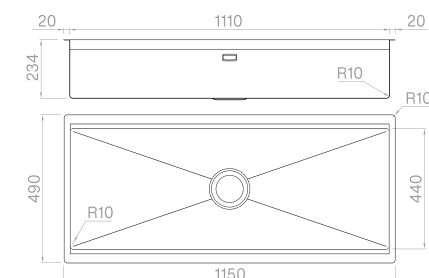

Accessories on page 32

PLANUM XT 81

READY



- Wooden chopping board
- Slanted colander
- Grid
- Loft Tap

- 1
- 23
- 10
- 38

 Under mount

Cod. **SAP0 81 XT**

PLANUM XT 81

PRO



- Wooden chopping board
- Slanted colander

- 1
- 23

 Under mount

Cod. **SBP0 81 XT**

PLANUM XT 81

SOLO



- |                    |                |
|--------------------|----------------|
| Material           | AISI 304       |
| Finishing          | Brushed        |
| Inner Corner       | R 10 mm Welded |
| Overall dimensions | 850 x 490 mm   |
| Basin dimensions   | 810 x 400 mm   |
| Bowl depth         | 234 mm         |
| Plus Strainer      | 3 ½"           |
| Cabinet size       | 900 mm         |

 Under mount

Cod. **PO 81 XT**

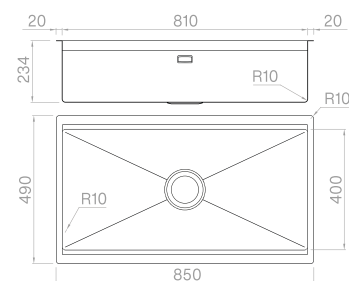

Accessories on page 32



Upper level



Oak wood chopping board

1

300x457x20 mm  
Cod. **TRIB 3045**



PaperStone® chopping board

55

300x460x20 mm  
Cod. **TRPS 3045**



Grid

10

300x457x25 mm  
Cod. **GRS 3045**

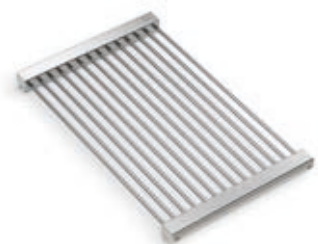

Lower level

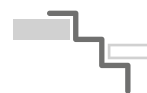

HDPE chopping board

6

240x420x20 mm  
Cod. **TRP 2442**



Colander

16

210x420x60 mm  
Cod. **VQSF 2142**

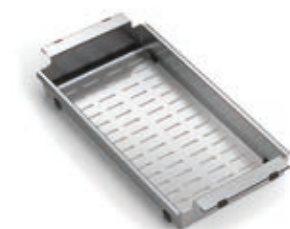

PaperStone® Strainer set

77

200x420x20 mm  
Cod. **TI 2442 SP**



PaperStone® Slicer/grater set

75

200x420x20 mm  
Cod. **TI 2442 GP**



Oak wood bottle holder set

7

130x457x170 mm  
Cod. **VPB 3C**



PaperStone® bottle holder set

72

130x457x170 mm  
Cod. **VPB 3CPA**



Drainer

8

250x457x15 mm  
Cod. **VPB 2545**



Slanted colander

23

280x420x110/60 mm  
Cod. **VQSI 2842**



Basin

26

280x420x160 mm  
Cod. **VQSP 2842**



PaperStone® Gastronorm set

76

200x420x20 mm  
Cod. **TI 2442 VP**



Dish holder

36

250x420x55 mm  
Cod. **PPPB V400**



Drainer tray

61

340x420x30 mm  
Cod. **VQSI 3442**

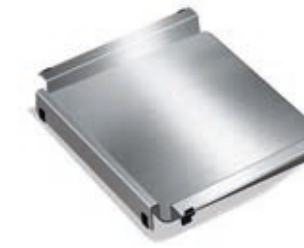

# PLANUM ST

The Planum collection is functional even in more contained space. The under-mount installation allows to maximize the fruition of the working area.



## PLANUM ST 111 READY



- Wooden chopping board **2**
- Slanted colander **25**
- Basin **27**
- Grid **11**
- Loft Tap **38**

Under mount Cod. **SAP0 11 L1**

## PLANUM ST 111 PRO



- Wooden chopping board **2**
- Slanted colander **25**

Under mount Cod. **SBP0 11 L1**

## PLANUM ST 111 SOLO



- Material AISI 304
- Finishing Brushed
- Inner Corner R 10 mm Welded
- Overall dimensions 1150 x 440 mm
- Basin dimensions 1110 x 350 mm
- Bowl depth 234 mm
- Plus Strainer 3 1/2"
- Cabinet size 1200 mm

Under mount Cod. **PO 11 L1**

Accessories on page 43

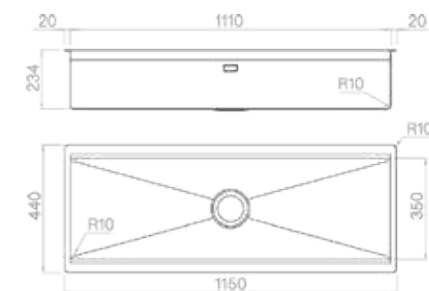

PLANUM ST 81 **READY**



- Wooden chopping board
- Slanted colander
- Grid
- Loft Tap

- 2
- 25
- 11
- 38

 Under mount

Cod. **SAP0 81 L1**

PLANUM ST 81 **PRO**



- Wooden chopping board
- Slanted colander

- 2
- 25

 Under mount

Cod. **SBPO 81 L1**

PLANUM ST 81 **SOLO**



- |                    |                |
|--------------------|----------------|
| Material           | AISI 304       |
| Finishing          | Brushed        |
| Inner Corner       | R 10 mm Welded |
| Overall dimensions | 850 x 440 mm   |
| Basin dimensions   | 810 x 350 mm   |
| Bowl depth         | 234 mm         |
| Plus Strainer      | 3 ½"           |
| Cabinet size       | 900 mm         |

 Under mount

Cod. **PO 81 L1**

Accessories on page 43

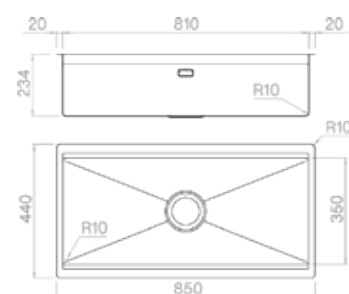

PLANUM ST 70 **READY**

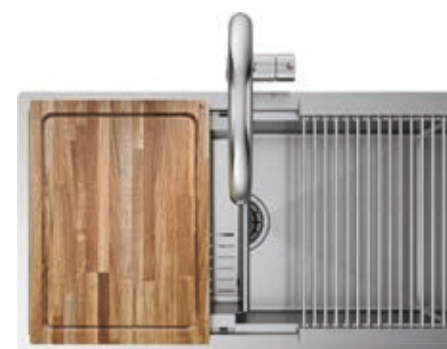

- Wooden chopping board
- Slanted colander
- Grid
- Loft Tap

- 2
- 25
- 11
- 38

 Under mount

Cod. **SAP0 70 L1**

PLANUM ST 70 **PRO**



- Wooden chopping board
- Slanted colander

- 2
- 25

 Under mount

Cod. **SBPO 70 L1**

PLANUM ST 70 **SOLO**



- |                    |                |
|--------------------|----------------|
| Material           | AISI 304       |
| Finishing          | Brushed        |
| Inner Corner       | R 10 mm Welded |
| Overall dimensions | 740 x 440 mm   |
| Basin dimensions   | 700 x 350 mm   |
| Bowl depth         | 234 mm         |
| Plus Strainer      | 3 ½"           |
| Cabinet size       | 800 mm         |

 Under mount

Cod. **PO 70 L1**

Accessories on page 43

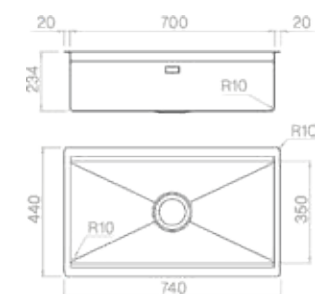

# PLANUM BR

All Planum workstations feature a double slide level. Multiple combinations of accessories ensure maximum customization of the working area.



## PLANUM BR 111 READY



- Wooden chopping board **2**
- Slanted colander **25**
- Basin **27**
- Grid **11**
- Loft Tap **38**

Top mount

Cod. **SAP BRI 11**

## PLANUM BR 111 PRO



- Wooden chopping board **2**
- Slanted colander **25**

Top mount

Cod. **SBP BRI 11**

## PLANUM BR 111 SOLO



- Material AISI 304
- Finishing Brushed
- Inner Corner R 10 mm Welded
- Overall dimensions 1160 x 505 mm
- Basin dimensions 1110 x 350 mm
- Bowl depth 254 mm
- Plus Strainer 3 1/2"
- Cabinet size 1200 mm

Top mount

Cod. **ALP BRI 11**

Mixer hole:  
specify extra  
holes when  
ordering.

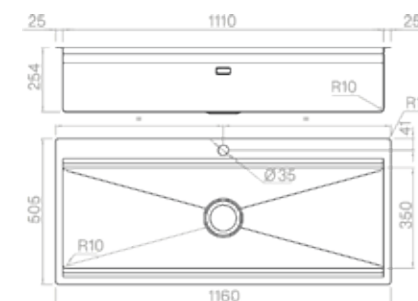

Accessories on page 43

**PLANUM BR 81** **READY**



- Wooden chopping board
- Slanted colander
- Grid
- Loft Tap

2  
25  
11  
38

Top mount

Cod. **SAP BRI 81**

**PLANUM BR 81** **PRO**



- Wooden chopping board
- Slanted colander

2  
25

Top mount

Cod. **SBP BRI 81**

**PLANUM BR 81** **SOLO**



- |                    |                |
|--------------------|----------------|
| Material           | AISI 304       |
| Finishing          | Brushed        |
| Inner Corner       | R 10 mm Welded |
| Overall dimensions | 860 x 505 mm   |
| Basin dimensions   | 810 x 350 mm   |
| Bowl depth         | 254 mm         |
| Plus Strainer      | 3 ½"           |
| Cabinet size       | 900 mm         |

Top mount

Cod. **ALP BRI 81**

Mixer hole: specify extra holes when ordering.

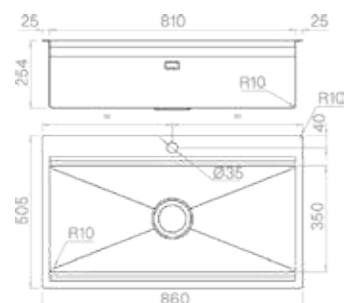

Accessories on page 43

**PLANUM BR 70** **READY**



- Wooden chopping board
- Slanted colander
- Grid
- Loft Tap

2  
25  
11  
38

Top mount

Cod. **SAP BRI 70**

**PLANUM BR 70** **PRO**



- Wooden chopping board
- Slanted colander

2  
25

Top mount

Cod. **SBP BRI 70**

**PLANUM BR 70** **SOLO**



- |                    |                |
|--------------------|----------------|
| Material           | AISI 304       |
| Finishing          | Brushed        |
| Inner Corner       | R 10 mm Welded |
| Overall dimensions | 750 x 505 mm   |
| Basin dimensions   | 700 x 350 mm   |
| Bowl depth         | 254 mm         |
| Plus Strainer      | 3 ½"           |
| Cabinet size       | 800 mm         |

Top mount

Cod. **ALP BRI 70**

Mixer hole: specify extra holes when ordering.

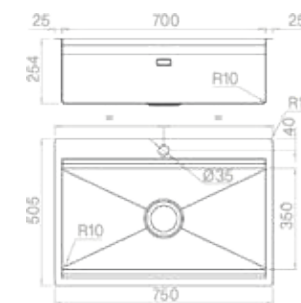

Accessories on page 43



Upper level



Oak wood chopping board

2

300x407x20 mm  
Cod. **TRIB 3041**



PaperStone® chopping board

53

300x407x20 mm  
Cod. **TRPS 3041**



Drainer

9

250x407x15 mm  
Cod. **VPB 2541**

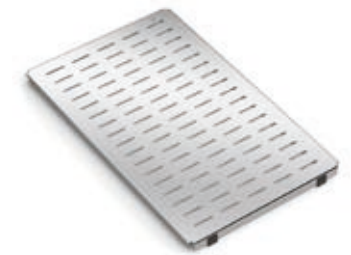

Grid

11

300x407x25 mm  
Cod. **GRS 3041**



Chopping board + gastronorm set

31

300x405x100 mm  
Cod. **TPLB 3V**



Chopping board + pasta strainer set

33

300x405x100 mm  
Cod. **TPLB 1S**



Chopping board + knife holder frame set

35

300x405x20 mm  
Cod. **TPLB 4030**



Lower level



Colander

20

210x375x60 mm  
Cod. **VQSF 2137**



Slanted colander

25

280x370x110/60 mm  
Cod. **VQSI 2837**



Basin

27

280x370x160 mm  
Cod. **VQSP 2837**



LAYER



# LAYER BRL

An essential and functional aesthetics is achieved through the wide depth which improves capacity. Everything is contained within the workstation space where sliding accessories are perfectly aligned to the working surface.



LAYER BRL 104 **READY**



- Wooden chopping board
- Colander
- Grid
- Element Tap

4  
48  
14  
40

- Top mount
- Under mount

Cod. **SA BRL I 10**  
Cod. **SA BRLO 10**

LAYER BRL 104 **PRO**



- Wooden chopping board
- Colander

4  
48

- Top mount
- Under mount

Cod. **SB BRL I 10**  
Cod. **SB BRLO 10**

LAYER BRL 104 **SOLO**



- |                    |                  |
|--------------------|------------------|
| Material           | AISI 304         |
| Finishing          | Brushed          |
| Inner Corner       | '0' Radius angle |
| Overall dimensions | 1080 x 510 mm    |
| Basin dimensions   | 960 x 410 mm     |
| Bowl depth         | 230 mm           |
| Plus Strainer      | 3 ½"             |
| Cabinet size       | 1200 mm          |

- Top mount
- Under mount

Cod. **AL BRL I 10**  
Cod. **AL BRLO 10**

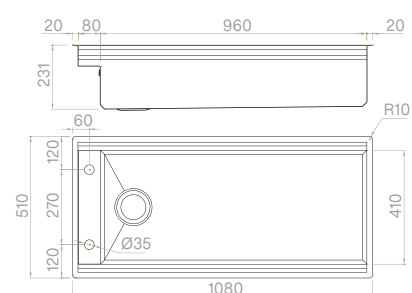

Accessories on page 51

LAYER BRL 74 **READY**



- Wooden chopping board
- Colander
- Element Tap

4  
48  
40

- Top mount
- Under mount

Cod. **SA BRL I 74**  
Cod. **SA BRLO 74**

LAYER BRL 74 **PRO**



- Wooden chopping board

4

- Top mount
- Under mount

Cod. **SB BRL I 74**  
Cod. **SB BRLO 74**

LAYER BRL 74 **SOLO**



- |                    |                  |
|--------------------|------------------|
| Material           | AISI 304         |
| Finishing          | Brushed          |
| Inner Corner       | '0' Radius angle |
| Overall dimensions | 780 x 510 mm     |
| Basin dimensions   | 660 x 410 mm     |
| Bowl depth         | 230 mm           |
| Plus Strainer      | 3 ½"             |
| Cabinet size       | 900 mm           |

- Top mount
- Under mount

Cod. **AL BRL I 74**  
Cod. **AL BRLO 74**

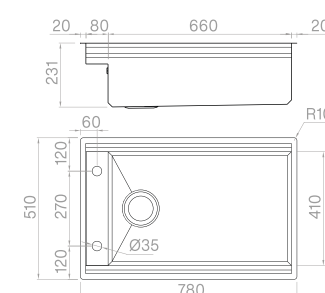

Accessories on page 51

LAYER BRL 50

READY



- Wooden chopping board
- Colander
- Circle Tap

4  
21  
45

- Top mount
- Under mount

Cod. **SA BRL I 50**  
Cod. **SA BRLO 50**

LAYER BRL 50

PRO



- Circle Tap

45

- Top mount
- Under mount

Cod. **SB BRL I 50**  
Cod. **SB BRLO 50**

LAYER BRL 50

SOLO



- Material AISI 304
- Finishing Brushed
- Inner Corner '0' Radius angle
- Overall dimensions 540 x 510 mm
- Basin dimensions 420 x 410 mm
- Bowl depth 230 mm
- Plus Strainer 3 1/2"
- Cabinet size 600 mm

- Top mount
- Under mount

Cod. **AL BRL I 50**  
Cod. **AL BRLO 50**

Accessories on page 51

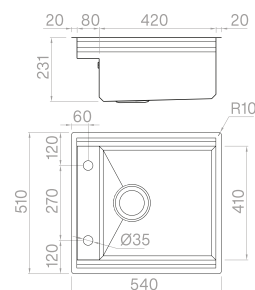

Upper level



Acacia wood chopping board

4

345x465x25 mm  
Cod. **TBRL 4634**



Grid

14

300x465x25 mm  
Cod. **GFL 4630**



PaperStone® chopping board

●

345x465x20 mm  
Cod. **TPBR 4634**



Lower level



Colander

21

190x435x80 mm  
Cod. **VFPB RL19**



Basin

28

345x435x160 mm  
Cod. **VGB RL34**



Colander

48

345x435x80 mm  
Cod. **VFGB RL34**



# LAYER SBR SP



## LAYER SBR SP 81

### READY



- Wooden chopping board
- Colander
- Grid
- Hero Tap

5  
49  
15  
39

- Top mount
- Under mount

Cod. **SASB 81 SP**  
Cod. **SASB 81 PS**

## LAYER SBR SP 81

### PRO



- Wooden chopping board
- Colander

5  
49

- Top mount
- Under mount

Cod. **SBSB 81 SP**  
Cod. **SBSB 81 PS**

## LAYER SBR SP 81

### SOLO



- Material: AISI 304
- Finishing: Brushed
- Inner Corner: '0' Radius angle
- Overall dimensions: 850 x 450 mm
- Basin dimensions: 810 x 350 mm
- Bowl depth: 240 mm
- Standard strainer: 3 1/2"
- Cabinet size: 900 mm

- Top mount
- Under mount

Cod. **ALSB 81 SP**  
Cod. **ALSB 81 PS**

Mixer hole: specify extra holes when ordering.

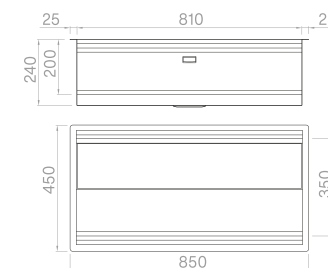

Accessories on page 71

# LAYER SBR

An iconic workstation featuring cutting boards, trays, and numerous special sliding accessories that allow for a functional and customizable work area with endless possibilities.



## LAYER SBR 104

### READY



- Wooden chopping board
- Colander
- Grid
- Element Tap

5  
49  
15  
40

-  Top mount
-  Under mount

Cod. **SA SBR 104**  
Cod. **SA SBR ST1**

## LAYER SBR 104

### PRO



- Wooden chopping board
- Colander

5  
49

-  Top mount
-  Under mount



Cod. **SB SBR 104**  
Cod. **SB SBR ST1**

## LAYER SBR 104

### SOLO



- Material AISI 304
- Finishing Brushed
- Inner Corner '0' Radius angle
- Overall dimensions 1080 x 450 mm
- Basin dimensions 1040 x 350 mm
- Bowl depth 210 mm
- Plus Strainer 3 1/2"
- Cabinet size 1200 mm

-  Top mount
-  Under mount

Cod. **SBR 104**  
Cod. **SBR ST 104**

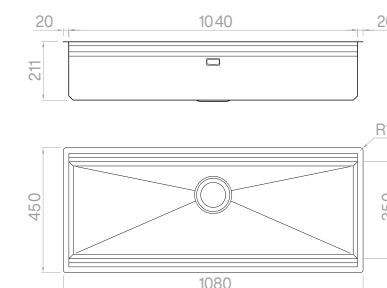

Accessories on page 71

LAYER SBR 81 READY



- Wooden chopping board
- Colander
- Grid
- Vertigo Tap

- 5
- 49
- 15
- 47

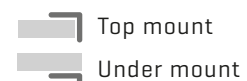

Cod. **SA SBR 81**  
Cod. **SA SBR ST8**

LAYER SBR 70 READY



- Wooden chopping board
- Colander
- Grid
- Vertigo Tap

- 5
- 22
- 15
- 47



Cod. **SA SBR 70**  
Cod. **SA SBR ST7**

LAYER SBR 81 PRO



- Wooden chopping board
- Colander

- 5
- 49

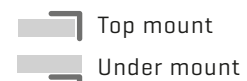

Cod. **SB SBR 81**  
Cod. **SB SBR ST8**

LAYER SBR 70 PRO



- Wooden chopping board
- Colander

- 5
- 22



Cod. **SB SBR 70**  
Cod. **SB SBR ST7**

LAYER SBR 81 SOLO



- |                    |                  |
|--------------------|------------------|
| Material           | AISI 304         |
| Finishing          | Brushed          |
| Inner Corner       | '0' Radius angle |
| Overall dimensions | 850 x 450 mm     |
| Basin dimensions   | 810 x 350 mm     |
| Bowl depth         | 210 mm           |
| Plus Strainer      | 3 ½"             |
| Cabinet size       | 900 mm           |

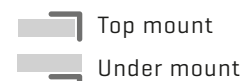

Cod. **SBR 81**  
Cod. **SBR ST 81**

LAYER SBR 70 SOLO



- |                    |                  |
|--------------------|------------------|
| Material           | AISI 304         |
| Finishing          | Brushed          |
| Inner Corner       | '0' Radius angle |
| Overall dimensions | 740 x 450 mm     |
| Basin dimensions   | 700 x 350 mm     |
| Bowl depth         | 210 mm           |
| Plus Strainer      | 3 ½"             |
| Cabinet size       | 800 mm           |



Cod. **SBR 70**  
Cod. **SBR ST 70**

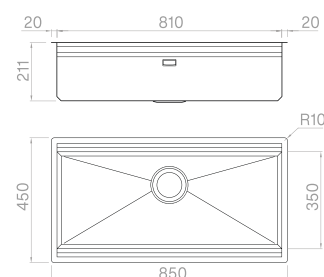

Accessories on page 71

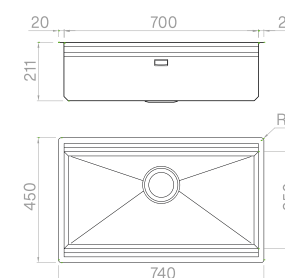

Accessories on page 71

LAYER SBR 65 READY



- Wooden chopping board
- Colander
- Vertigo Tap

5  
22  
47

- Top mount
- Under mount

Cod. **SA SBR 65**  
Cod. **SA SBR ST6**

LAYER SBR 65 PRO



- Wooden chopping board

5

- Top mount
- Under mount

Cod. **SB SBR 65**  
Cod. **SB SBR ST6**

LAYER SBR 65 SOLO



- Material AISI 304
- Finishing Brushed
- Inner Corner '0' Radius angle
- Overall dimensions 690 x 450 mm
- Basin dimensions 650 x 350 mm
- Bowl depth 210 mm
- Plus Strainer 3 1/2"
- Cabinet size 750 mm

- Top mount
- Under mount

Cod. **SBR 65**  
Cod. **SBR ST 65**

Accessories on page 71

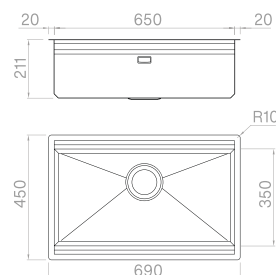

LAYER SBR 50 READY



- Wooden chopping board
- Colander
- Vertigo Tap

5  
22  
47

- Top mount
- Under mount

Cod. **SA SBR 50**  
Cod. **SA SBR ST5**

LAYER SBR 50 PRO



- Wooden chopping board

5

- Top mount
- Under mount

Cod. **SB SBR 50**  
Cod. **SB SBR ST5**

LAYER SBR 50 SOLO



- Material AISI 304
- Finishing Brushed
- Inner Corner '0' Radius angle
- Overall dimensions 540 x 450 mm
- Basin dimensions 500 x 350 mm
- Bowl depth 210 mm
- Plus Strainer 3 1/2"
- Cabinet size 600 mm

- Top mount
- Under mount

Cod. **SBR 50**  
Cod. **SBR ST 50**

Accessories on page 71

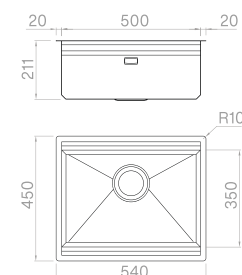

# LAYER SP



The exclusive design of Layer SP is characterized by a clean aesthetic. It features a functional opening at the bottom, concealing the drainage underneath.

LAYER SP 81 READY



- Wooden chopping board 5
- Colander 49
- Grid 15
- Hero Tap 39

Top mount Cod. **SA BR81 SP**

LAYER SP 70 READY



- Wooden chopping board 5
- Colander 22
- Grid 15
- Hero Tap 39

Top mount Cod. **SA BR70 SP**

LAYER SP 81 PRO



- Wooden chopping board 5
- Colander 49

Top mount Cod. **SB BR81 SP**

LAYER SP 70 PRO



- Wooden chopping board 5
- Colander 22

Top mount Cod. **SB BR70 SP**

LAYER SP 81 SOLO



- |                               |                  |
|-------------------------------|------------------|
| Material                      | AISI 304         |
| Finishing                     | Brushed          |
| Inner Corner                  | '0' Radius angle |
| Overall dimensions            | 860 x 510 mm     |
| Basin dimensions              | 810 x 350 mm     |
| Bowl depth                    | 240 mm           |
| Automatic pop-up drain system | 3 1/2"           |
| Cabinet size                  | 900 mm           |

Top mount Cod. **AL BR81 SP**

LAYER SP 70 SOLO



- |                               |                  |
|-------------------------------|------------------|
| Material                      | AISI 304         |
| Finishing                     | Brushed          |
| Inner Corner                  | '0' Radius angle |
| Overall dimensions            | 740 x 510 mm     |
| Basin dimensions              | 700 x 350 mm     |
| Bowl depth                    | 240 mm           |
| Automatic pop-up drain system | 3 1/2"           |
| Cabinet size                  | 800 mm           |

Top mount Cod. **AL BR70 SP**

Mixer hole: specify extra holes when ordering.

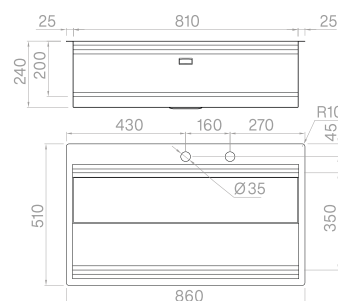

Accessories on page 71

Mixer hole: specify extra holes when ordering.

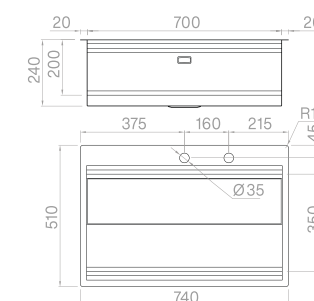

Accessories on page 71

# LAYER BRP

An exclusive inclined design, where dedicated accessories slide on two levels. The upper level, intended for racks and cutting boards, is complemented by a lower level, where trays and containers provide maximum functionality.



## LAYER BRP 104

READY



- Wooden chopping board
- Colander
- Grid
- Element Tap

5  
49  
15  
40

Top mount

Cod. **SA BRP 104**

## LAYER BRP 104

PRO



- Wooden chopping board
- Colander

5  
49

Top mount

Cod. **SB BRP 104**

## LAYER BRP 104

SOLO



- Material AISI 304
- Finishing Brushed
- Inner Corner '0' Radius angle
- Overall dimensions 1080 x 510 mm
- Basin dimensions 1040 x 350 mm
- Bowl depth 210 mm
- Plus Strainer 3 1/2"
- Cabinet size 1200 mm

Top mount

Cod. **AL BRP 104**

Mixer hole:  
specify extra  
holes when  
ordering.

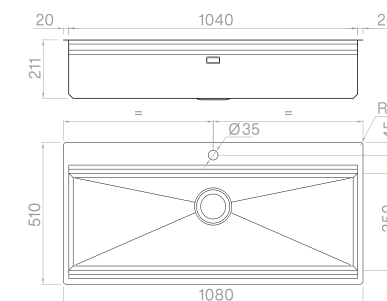

Accessories on page 71

LAYER BRP 81 READY



- Wooden chopping board 5
- Colander 49
- Grid 15
- Vertigo Tap 47

Top mount Cod. **SA BRP 81**

LAYER BRP 70 READY



- Wooden chopping board 5
- Colander 22
- Grid 15
- Vertigo Tap 47

Top mount Cod. **SA BRP 70**

LAYER BRP 81 PRO



- Wooden chopping board 5
- Colander 49

Top mount Cod. **SB BRP 81**

LAYER BRP 70 PRO



- Wooden chopping board 5
- Colander 22

Top mount Cod. **SB BRP 70**

LAYER BRP 81 SOLO



- |                    |                  |
|--------------------|------------------|
| Material           | AISI 304         |
| Finishing          | Brushed          |
| Inner Corner       | '0' Radius angle |
| Overall dimensions | 860 x 510 mm     |
| Basin dimensions   | 810 x 350 mm     |
| Bowl depth         | 210 mm           |
| Plus Strainer      | 3 ½"             |
| Cabinet size       | 900 mm           |

Top mount Cod. **AL BRP 81**

LAYER BRP 70 SOLO



- |                    |                  |
|--------------------|------------------|
| Material           | AISI 304         |
| Finishing          | Brushed          |
| Inner Corner       | '0' Radius angle |
| Overall dimensions | 740 x 510 mm     |
| Basin dimensions   | 700 x 350 mm     |
| Bowl depth         | 210 mm           |
| Plus Strainer      | 3 ½"             |
| Cabinet size       | 800 mm           |

Top mount Cod. **AL BRP 70**

Mixer hole: specify extra holes when ordering.

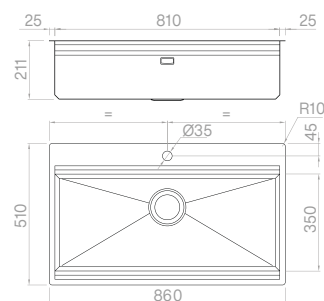

Accessories on page 71

Mixer hole: specify extra holes when ordering.

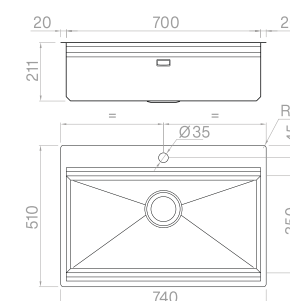

Accessories on page 71

LAYER BRP 65 READY

- Wooden chopping board
- Colander
- Vertigo Tap

5  
22  
47



Top mount Cod. **SA BRP 65**

LAYER BRP 65 PRO

- Wooden chopping board

5



Top mount Cod. **SB BRP 65**

LAYER BRP 65 SOLO

- |                    |                  |
|--------------------|------------------|
| Material           | AISI 304         |
| Finishing          | Brushed          |
| Inner Corner       | '0' Radius angle |
| Overall dimensions | 690 x 510 mm     |
| Basin dimensions   | 650 x 350 mm     |
| Bowl depth         | 210 mm           |
| Plus Strainer      | 3 1/2"           |
| Cabinet size       | 750 mm           |



Top mount Cod. **AL BRP 65**

Mixer hole: specify extra holes when ordering.

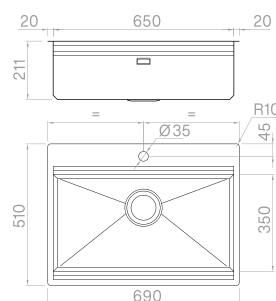

Accessories on page 71

LAYER BRP 50 READY

- Wooden chopping board
- Colander
- Vertigo Tap

5  
22  
47



Top mount Cod. **SA BRP 50**

LAYER BRP 50 PRO

- Wooden chopping board

5



Top mount Cod. **SB BRP 50**

LAYER BRP 50 SOLO

- |                    |                  |
|--------------------|------------------|
| Material           | AISI 304         |
| Finishing          | Brushed          |
| Inner Corner       | '0' Radius angle |
| Overall dimensions | 540 x 510 mm     |
| Basin dimensions   | 500 x 350 mm     |
| Bowl depth         | 210 mm           |
| Plus Strainer      | 3 1/2"           |
| Cabinet size       | 600 mm           |



Top mount Cod. **AL BRP 50**

Mixer hole: specify extra holes when ordering.

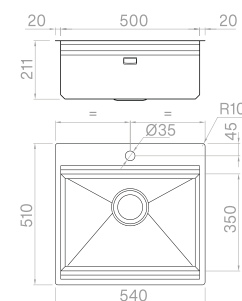

Accessories on page 71

Upper level



Acacia wood chopping board **5**

300x405x25 mm  
Cod. **TSBR 4030**



Grid **15**

300x405x25 mm  
Cod. **GFL 4030**



PaperStone® chopping board **57**

300x405x20 mm  
Cod. **TPBR 4030**



Chopping board +  
gastronorm set **31**

300x405x100 mm  
Cod. **TPLB 3V**



Chopping board +  
pasta strainer set **33**

300x405x100 mm  
Cod. **TPLB 1S**



Chopping board +  
knife holder frame set **35**

300x405x20 mm  
Cod. **TPLB 4030**



Dish holder **37**

250x400x55 mm  
Cod. **PPPB SBR**



Lower level



Colander **22**

190x375x80 mm  
Cod. **VFP SBR19**



Basin **29**

300x375x160 mm  
Cod. **VGS BR34**

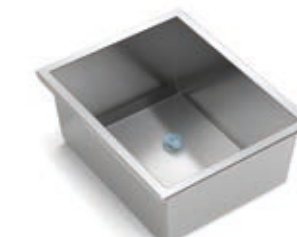

Colander **49**

300x375x80 mm  
Cod. **VFG SBR34**





INTEGRATED

# LINEA

The main feature of the Linea collection is the exclusive edgeless installation, where the junction between the sink and the countertop meets to an ideally minimum edge, maximizing aesthetics and cleanliness.



**LINEA 70** **READY**



- Wooden chopping board **3**
- Slanted colander **23**
- Basin **26**
- Element Tap **40**

Edgeless Cod. **SAL 70**

**LINEA 70** **PRO**



Colander **16**

Edgeless Cod. **SBL 70**

**LINEA 70** **SOLO**



- |                    |                |
|--------------------|----------------|
| Material           | AISI 304       |
| Finishing          | Brushed        |
| Inner Corner       | R 10 mm Welded |
| Overall dimensions | -              |
| Basin dimensions   | 700 x 400 mm   |
| Bowl depth         | 200 mm         |
| Standard strainer  | 3 ½"           |
| Cabinet size       | 800 mm         |

Edgeless Cod. **L 70**

Accessories on page 83

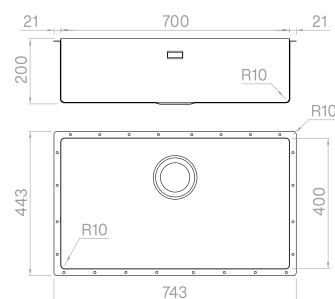

**LINEA 65** **READY**



- Wooden chopping board **3**
- Slanted colander **23**
- Uber Tap **46**

Edgeless Cod. **SAL 65**

**LINEA 65** **PRO**



Colander **16**

Edgeless Cod. **SBL 65**

**LINEA 65** **SOLO**



- |                    |                |
|--------------------|----------------|
| Material           | AISI 304       |
| Finishing          | Brushed        |
| Inner Corner       | R 10 mm Welded |
| Overall dimensions | -              |
| Basin dimensions   | 650 x 400 mm   |
| Bowl depth         | 200 mm         |
| Standard strainer  | 3 ½"           |
| Cabinet size       | 750 mm         |

Edgeless Cod. **L 65**

Accessories on page 83

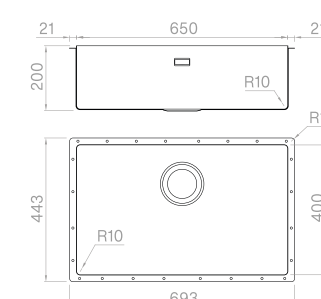

LINEA 50

READY



- Wooden chopping board
- Slanted colander
- Uber Tap

3  
23  
46

Edgeless

Cod. **SAL 50**

LINEA 50

PRO



- Colander

16

Edgeless

Cod. **SBL 50**

LINEA 50

SOLO



- |                    |                |
|--------------------|----------------|
| Material           | AISI 304       |
| Finishing          | Brushed        |
| Inner Corner       | R 10 mm Welded |
| Overall dimensions | -              |
| Basin dimensions   | 500 x 400 mm   |
| Bowl depth         | 200 mm         |
| Standard strainer  | 3 ½"           |
| Cabinet size       | 600 mm         |

Edgeless

Cod. **L 50**

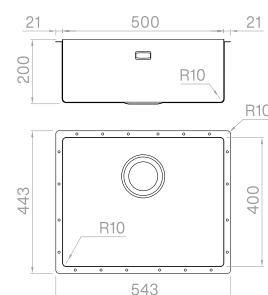

Accessories on page 83

LINEA 45

READY

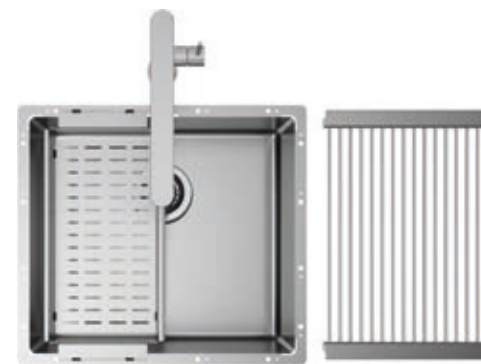

- Grid
- Colander
- Uber Tap

12  
16  
46

Edgeless

Cod. **SAL 45**

LINEA 45

PRO



- Colander

16

Edgeless

Cod. **SBL 45**

LINEA 45

SOLO



- |                    |                |
|--------------------|----------------|
| Material           | AISI 304       |
| Finishing          | Brushed        |
| Inner Corner       | R 10 mm Welded |
| Overall dimensions | -              |
| Basin dimensions   | 450 x 400 mm   |
| Bowl depth         | 200 mm         |
| Standard strainer  | 3 ½"           |
| Cabinet size       | 600 mm         |

Edgeless

Cod. **L 45**

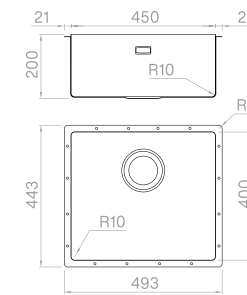

Accessories on page 83

LINEA 40

READY

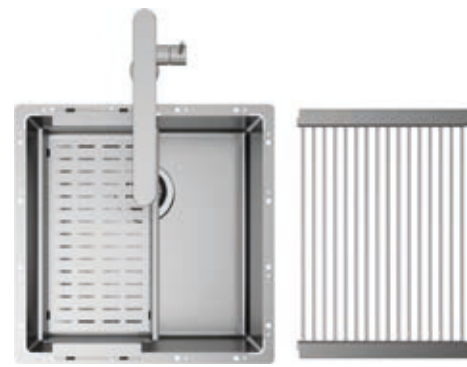

- Grid **12**
- Colander **16**
- Uber Tap **46**

Edgeless

Cod. **SAL 40**

LINEA 40

PRO



- Colander **16**

Edgeless

Cod. **SBL 40**

LINEA 40

SOLO



- Material AISI 304
- Finishing Brushed
- Inner Corner R 10 mm Welded
- Overall dimensions -
- Basin dimensions 400 x 400 mm
- Bowl depth 200 mm
- Standard strainer 3 ½"
- Cabinet size 450 mm

Edgeless

Cod. **L 40**

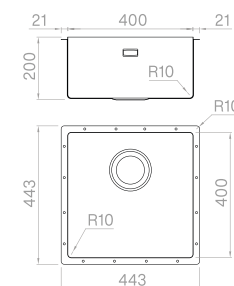

Accessories on page 83

LINEA 34

READY

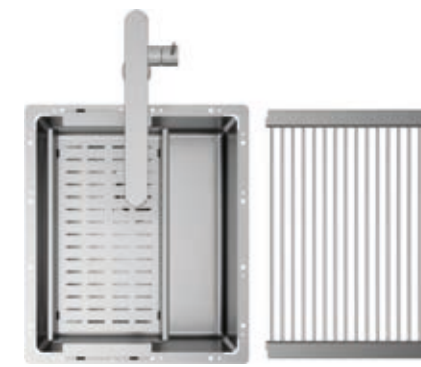

- Grid **12**
- Colander **16**
- Uber Tap **46**

Edgeless

Cod. **SAL 34**

LINEA 34

PRO



- Colander **16**

Edgeless

Cod. **SBL 34**

LINEA 34

SOLO



- Material AISI 304
- Finishing Brushed
- Inner Corner R 10 mm Welded
- Overall dimensions -
- Basin dimensions 340 x 400 mm
- Bowl depth 200 mm
- Standard strainer 3 ½"
- Cabinet size 450 mm

Edgeless

Cod. **L 34**

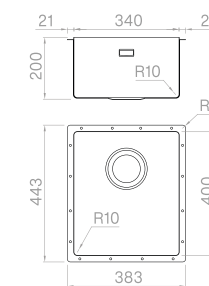

Accessories on page 83



Oak wood chopping board

3

300x420x20 mm

Cod. **TRIB 3042**



HDPE chopping board

6

240x420x20 mm

Cod. **TRP 2442**



PaperStone® chopping board

54

300x420x20 mm

Cod. **TRPS 3042**



Grid

12

250x420x25 mm

Cod. **GRS 2542**

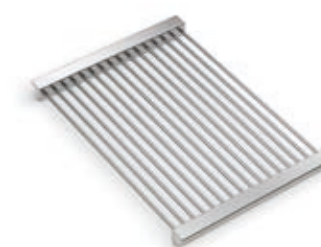

Colander

16

210x420x60 mm

Cod. **VQSF 2142**

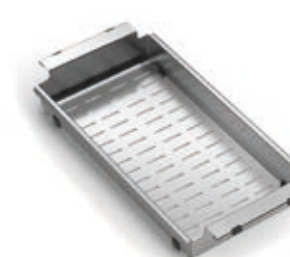

Slanted colander

23

280x420x110/60 mm

Cod. **VQSI 2842**



Basin

26

280x420x160 mm

Cod. **VQSP 2842**



Gastronorm set

30

240x420x100 mm

Cod. **TI 2442 V**



Strainer set

32

240x420x20 mm

Cod. **TI 2442 1S**



Slicer/grater set

34

200x420x70 mm

Cod. **TI 2442 PG**



Plate holder

36

250x420x55 mm

Cod. **PPPB V400**



Drainer tray

61

340x420x30 mm

Cod. **VQSI 3442**



# SHORE

Shore features an innovative installation with coated inner walls that continue seamlessly into the worktop surrounding a visible stainless-steel bottom, outlined by an exclusive 45° inclined design.



SHORE 70

READY



- Wooden chopping board
- Slanted colander
- Element Tap

3  
23  
40

Integrated 12 mm Cod. **SASH 70**

SHORE 65

READY



- Wooden chopping board
- Slanted colander
- Element Tap

3  
23  
40

Integrated 12 mm Cod. **SASH 65**

SHORE 70

PRO



Colander

16

Integrated 12 mm Cod. **SBSH 70**

SHORE 65

PRO



Colander

16

Integrated 12 mm Cod. **SBSH 65**

SHORE 70

SOLO



Material	AISI 304
Finishing	Brushed
Inner Corner	R 0 mm Welded
Overall dimensions	766 x 466 mm
Basin dimensions	700 x 400 mm
Bowl depth	175 mm
Standard strainer	3 ½"
Cabinet size	800 mm

Integrated 12 mm Cod. **SH 70**

SHORE 65

SOLO



Material	AISI 304
Finishing	Brushed
Inner Corner	R 0 mm Welded
Overall dimensions	716 x 466 mm
Basin dimensions	650 x 400 mm
Bowl depth	175 mm
Standard strainer	3 ½"
Cabinet size	750 mm

Integrated 12 mm Cod. **SH 65**

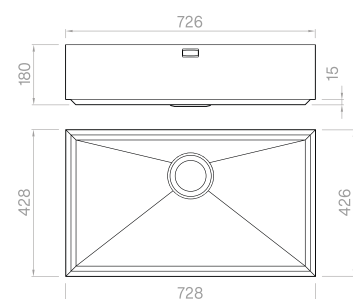

Accessories on page 93

Integrated 20 mm On request

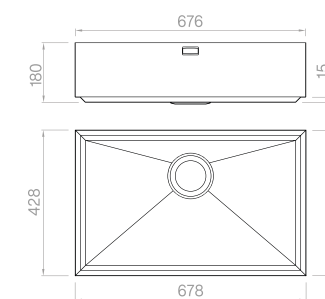

Accessories on page 93

Integrated 20 mm On request

**SHORE 50** **READY**



- Wooden chopping board **3**
- Slanted colander **23**
- Element Tap **40**

 Integrated 12 mm Cod. **SASH 50**

**SHORE 50** **PRO**



- Colander **16**

 Integrated 12 mm Cod. **SBSH 50**

**SHORE 50** **SOLO**



Material	AISI 304
Finishing	Brushed
Inner Corner	R 0 mm Welded
Overall dimensions	566 x 466 mm
Basin dimensions	500 x 400 mm
Bowl depth	175 mm
Standard strainer	3 ½"
Cabinet size	600 mm

 Integrated 12 mm Cod. **SH 50**

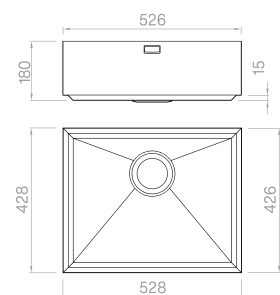

Accessories on page 93

 **20 mm** On request

**SHORE 45** **READY**



- Grid **12**
- Colander **16**
- Uber Tap **46**

 Integrated 12 mm Cod. **SASH 45**

**SHORE 45** **PRO**



- Colander **16**

 Integrated 12 mm Cod. **SBSH 45**

**SHORE 45** **SOLO**



Material	AISI 304
Finishing	Brushed
Inner Corner	R 0 mm Welded
Overall dimensions	516 x 466 mm
Basin dimensions	450 x 400 mm
Bowl depth	175 mm
Standard strainer	3 ½"
Cabinet size	600 mm

 Integrated 12 mm Cod. **SH 45**

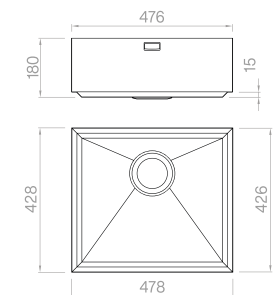

Accessories on page 93

 **20 mm** On request

SHORE 40 + 34

READY

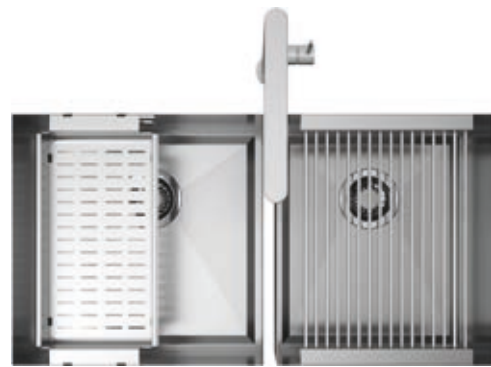

- Grid **12**
- Colander **16**
- Uber Tap **46**

Integrated 12 mm Cod. **SASH 40**

SHORE 34 + 34

READY

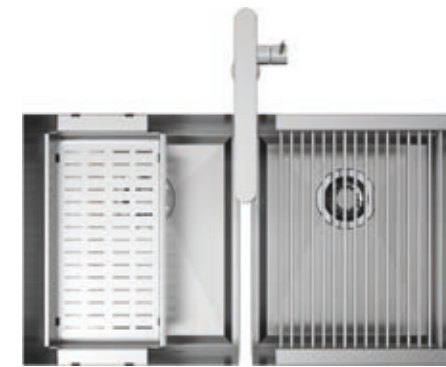

- Grid **12**
- Colander **16**
- Uber Tap **46**

Integrated 12 mm Cod. **SASH 34**

SHORE 40

PRO



- Colander **16**

Integrated 12 mm Cod. **SBSH 40**

SHORE 34

PRO



- Colander **16**

Integrated 12 mm Cod. **SBSH 34**

SHORE 40

SOLO



- Material AISI 304
- Finishing Brushed
- Inner Corner R 0 mm Welded
- Overall dimensions 466 x 466 mm
- Basin dimensions 400 x 400 mm
- Bowl depth 175 mm
- Standard strainer 3 ½"
- Cabinet size 600 mm

Integrated 12 mm Cod. **SH 40**

SHORE 34

SOLO



- Material AISI 304
- Finishing Brushed
- Inner Corner R 0 mm Welded
- Overall dimensions 406 x 466 mm
- Basin dimensions 340 x 400 mm
- Bowl depth 175 mm
- Standard strainer 3 ½"
- Cabinet size 450 mm

Integrated 12 mm Cod. **SH 34**

Accessories on page 93

Integrated 20 mm On request

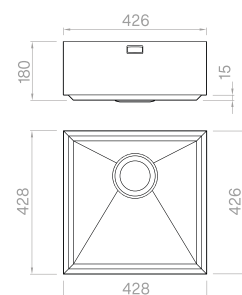

Accessories on page 93

Integrated 20 mm On request

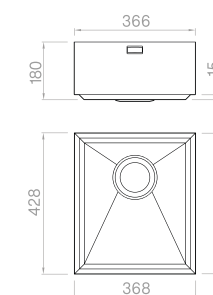

Oak wood chopping board

3

300x420x20 mm

Cod. **TRIB 3042**



HDPE chopping board

6

240x420x20 mm

Cod. **TRP 2442**



PaperStone® chopping board

54

300x420x20 mm

Cod. **TRPS 3042**



Grid

12

250x420x25 mm

Cod. **GRS 2542**



Colander

16

210x420x60 mm

Cod. **VQSF 2142**

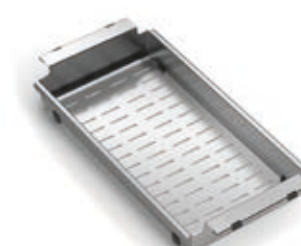

Slanted colander

23

280x420x110/60 mm

Cod. **VQSI 2842**



Basin

26

280x420x160 mm

Cod. **VQSP 2842**



Gastronorm set

30

240x420x100 mm

Cod. **TI 2442 V**



Strainer set

32

240x420x20 mm

Cod. **TI 2442 1S**



Slicer/grater set

34

200x420x70 mm

Cod. **TI 2442 PG**



Plate holder

36

250x420x55 mm

Cod. **PPPB V400**



Drainer tray

61

340x420x30 mm

Cod. **VQSI 3442**





SINKS



## TITANIUM

The PVD treatment is a non-toxic and durable technological process that allows to enhance the colour of stainless steel. Three exclusive Artinox finishes are available. Gun Metal, Copper Bronze, and Pale Gold are monochromatic solutions with a high aesthetic impact.

# TITANIUM GUN METAL



## TITANIUM 70 GUN METAL

READY

Colander Gun Metal  
Athom Tap

17  
42

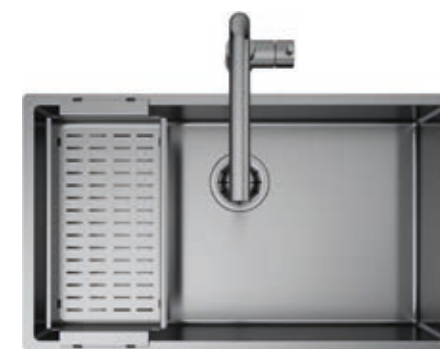

-  Top mount
-  Flush mount
-  Under mount

Cod. **SAT I 70 RA**  
Cod. **SATG 70 RA**  
Cod. **SATO 70 RA**

## TITANIUM 70 GUN METAL

PRO

Colander Gun Metal

17





-  Top mount
-  Flush mount
-  Under mount

Cod. **SBT I 70 RA**  
Cod. **SBTG 70 RA**  
Cod. **SBTO 70 RA**

## TITANIUM 70 GUN METAL

SOLO



Material	AISI 304
Finishing	PVD Gun Metal
Inner Corner	R 10 mm Welded
Overall dimensions	740 x 440 mm
Basin dimensions	700 x 400 mm
Bowl depth	200 mm
Plus Strainer Gun Metal	3 1/2"
Cabinet size	800 mm
 Top mount	Cod. <b>TI 7040 RA</b>
 Flush mount	Cod. <b>TG 7040 RA</b>
 Under mount	Cod. <b>TO 7040 RA</b>

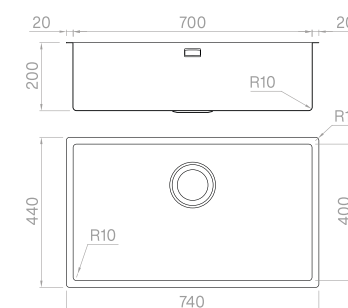

Accessories on page 101

## TITANIUM 50 GUN METAL

READY



Colander Gun Metal  
Atom Tap

17  
42

Top mount  
Flush mount  
Under mount

Cod. **SAT I 50 RA**  
Cod. **SATG 50 RA**  
Cod. **SATO 50 RA**

## TITANIUM 50 GUN METAL

PRO



Colander Gun Metal

17

Top mount  
Flush mount  
Under mount

Cod. **SBT I 50 RA**  
Cod. **SBTG 50 RA**  
Cod. **SBTO 50 RA**

## TITANIUM 50 GUN METAL

SOLO



Material	AISI 304
Finishing	PVD Gun Metal
Inner Corner	R 10 mm Welded
Overall dimensions	540 x 440 mm
Basin dimensions	500 x 400 mm
Bowl depth	200 mm
Plus Strainer Gun Metal	3 ½"
Cabinet size	600 mm

Top mount Cod. **TI 5040 RA**  
Flush mount Cod. **TG 5040 RA**  
Under mount Cod. **TO 5040 RA**

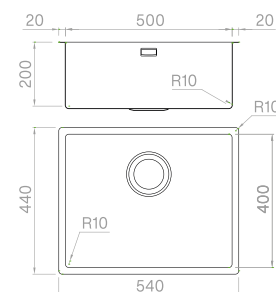

Accessories on page 101

## Oak wood chopping board

3

300x420x20 mm  
Cod. **TRIB 3042**



## HDPE chopping board

6

240x420x20 mm  
Cod. **TRP 2442**



## PaperStone® chopping board

73

200x420x19 mm  
Cod. **TRPS 2042**



## Colander Gun Metal

17

210x420x60 mm  
Cod. **VQAF 2142**

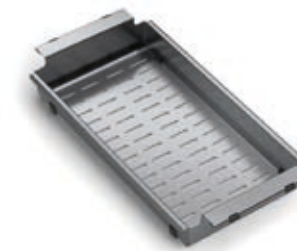

## PaperStone® Gastronorm set

76

240x420x20 mm  
Cod. **TI 2442 VP**



## PaperStone® Strainer set

77

240x420x20 mm  
Cod. **TI 2442 SP**



## PaperStone® Slicer/grater set

75

200x420x20 mm  
Cod. **TI 2442 GP**



# TITANIUM COPPER BRONZE



## TITANIUM 70 COPPER BRONZE READY

Colander Copper Bronze  
Athom Tap

18  
43

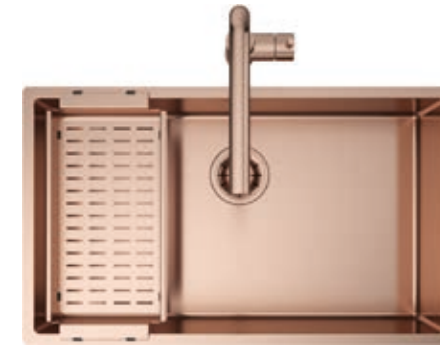

-  Top mount
-  Flush mount
-  Under mount



Cod. **SAT I 70 RC**  
Cod. **SATG 70 RC**  
Cod. **SATO 70 RC**

## TITANIUM 70 COPPER BRONZE PRO

Colander Copper Bronze

18





-  Top mount
-  Flush mount
-  Under mount

Cod. **SBT I 70 RC**  
Cod. **SBTG 70 RC**  
Cod. **SBTO 70 RC**

## TITANIUM 70 COPPER BRONZE SOLO



Material	AISI 304
Finishing	PVD Copper Bronze
Inner Corner	R 10 mm Welded
Overall dimensions	740 x 440 mm
Basin dimensions	700 x 400 mm
Bowl depth	200 mm
Plus Strainer Copper Bronze	3 1/2"
Cabinet size	800 mm

-  Top mount Cod. **TI 7040 RC**
-  Flush mount Cod. **TG 7040 RC**
-  Under mount Cod. **TO 7040 RC**

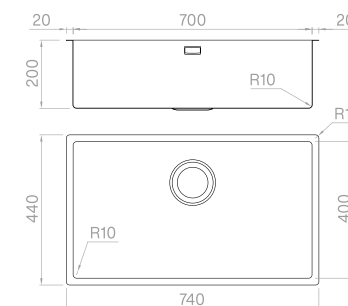

Accessories on page 105

## TITANIUM 50 COPPER BRONZE

READY



Colander Copper Bronze  
Athom Tap

18

43

Top mount  
Flush mount  
Under mount

Cod. **SAT I 50 RC**Cod. **SATG 50 RC**Cod. **SATO 50 RC**

## TITANIUM 50 COPPER BRONZE

PRO



Colander Copper Bronze

18

Top mount  
Flush mount  
Under mount

Cod. **SBT I 50 RC**Cod. **SBTG 50 RC**Cod. **SBTO 50 RC**

## TITANIUM 50 COPPER BRONZE

SOLO



Material	AISI 304
Finishing	PVD Copper Bronze
Inner Corner	R 10 mm Welded
Overall dimensions	540 x 440 mm
Basin dimensions	500 x 400 mm
Bowl depth	200 mm
Plus Strainer Copper Bronze	3 ½"
Cabinet size	600 mm

Top mount  
Flush mount  
Under mount

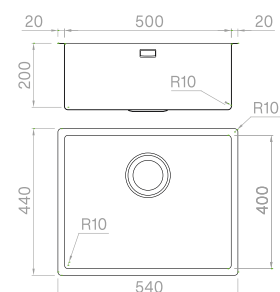
Cod. **TI 5040 RC**Cod. **TG 5040 RC**Cod. **TO 5040 RC**

Accessories on page 105

## Oak wood chopping board

3

300x420x20 mm  
Cod. **TRIB 3042**



## HDPE chopping board

6

240x420x20 mm  
Cod. **TRP 2442**



## PaperStone® chopping board

73

200x420x19 mm  
Cod. **TRPS 2042**



## Colander Copper Bronze

18

210x420x60 mm  
Cod. **VQCF 2142**



## PaperStone® Gastronorm set

76

200x420x20 mm  
Cod. **TI 2442 VP**



## PaperStone® Strainer set

77

200x420x20 mm  
Cod. **TI 2442 SP**



## PaperStone® Slicer/grater set

75

200x420x20 mm  
Cod. **TI 2442 GP**



## TITANIUM PALE GOLD



## TITANIUM 70 PALE GOLD

## READY

Colander Pale Gold  
Athom Tap

19

44

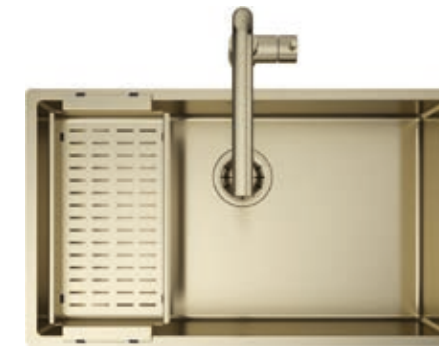

Top mount  
Flush mount  
Under mount

Cod. **SAT I 70 RG**Cod. **SATG 70 RG**Cod. **SATO 70 RG**

## TITANIUM 70 PALE GOLD

## PRO

Colander Pale Gold

19



Top mount  
Flush mount  
Under mount

Cod. **SBT I 70 RG**Cod. **SBTG 70 RG**Cod. **SBTO 70 RG**

## TITANIUM 70 PALE GOLD

## SOLO

Material	AISI 304
Finishing	PVD Pale Gold
Inner Corner	R 10 mm Welded
Overall dimensions	740 x 440 mm
Basin dimensions	700 x 400 mm
Bowl depth	200 mm
Plus Strainer Pale Gold	3 ½"
Cabinet size	800 mm

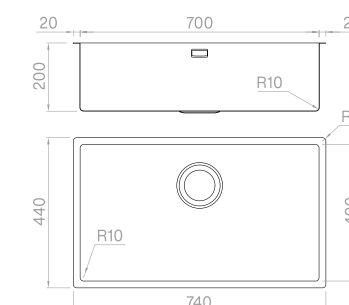

Top mount  
Flush mount  
Under mount

Cod. **TI 7040 RG**Cod. **TG 7040 RG**Cod. **TO 7040 RG**

Accessories on page 109

## TITANIUM 50 PALE GOLD

READY



Colander Pale Gold  
Athom Tap

19  
44

Top mount  
Flush mount  
Under mount

Cod. **SAT I 50 RG**  
Cod. **SATG 50 RG**  
Cod. **SATO 50 RG**

## TITANIUM 50 PALE GOLD

PRO



Colander Pale Gold

19

Top mount  
Flush mount  
Under mount

Cod. **SBT I 50 RG**  
Cod. **SBTG 50 RG**  
Cod. **SBTO 50 RG**

## TITANIUM 50 PALE GOLD

SOLO



Material	AISI 304
Finishing	PVD Pale Gold
Inner Corner	R 10 mm Welded
Overall dimensions	540 x 440 mm
Basin dimensions	500 x 400 mm
Bowl depth	200 mm
Plus Strainer Pale Gold	3 ½"
Cabinet size	600 mm

Top mount Cod. **TI 5040 RG**  
Flush mount Cod. **TG 5040 RG**  
Under mount Cod. **TO 5040 RG**

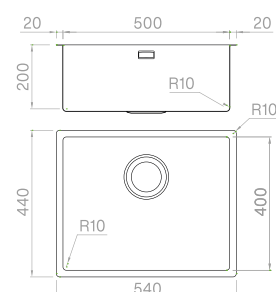

Accessories on page 109

## Oak wood chopping board

3

300x420x20 mm  
Cod. **TRIB 3042**



## HDPE chopping board

6

240x420x20 mm  
Cod. **TRP 2442**



## PaperStone® chopping board

73

200x420x19 mm  
Cod. **TRPS 2042**



## Colander Pale Gold

19

210x420x60 mm  
Cod. **VQGF 2142**

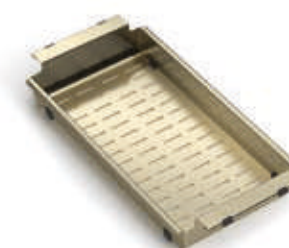

## PaperStone® Gastronorm set

76

200x420x20 mm  
Cod. **TI 2442 VP**



## PaperStone® Strainer set

77

200x420x20 mm  
Cod. **TI 2442 SP**



## PaperStone® Slicer/grater set

75

200x420x20 mm  
Cod. **TI 2442 GP**



RADIUS



# RADIUS MATTE VINTAGE

An elegant and sophisticated sinks family thanks to the combination of Matte Vintage stainless steel and the black finish of the mixers and accessories. Matte Vintage is an Artinox exclusive, characterized by a non-uniform surface that enhances the materiality of stainless steel.



## RADIUS MATTE VINTAGE 70

READY

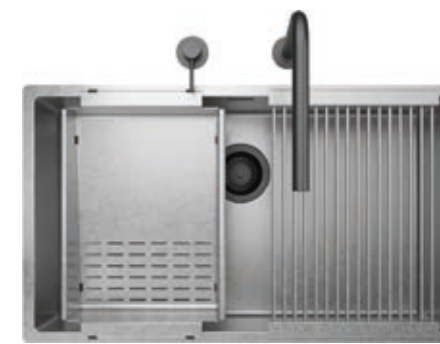

Grid  
Slanted colander  
Ergo Tap

13

24

41

Top mount  
Flush mount  
Under mount

Cod. **SAB I 70 RH**

Cod. **SABG 70 RH**

Cod. **SABO 70 RH**

## RADIUS MATTE VINTAGE 70

PRO



Slanted colander

24

Top mount  
Flush mount  
Under mount

Cod. **SBB I 70 RH**

Cod. **SBBG 70 RH**

Cod. **SBBO 70 RH**

## RADIUS MATTE VINTAGE 70

SOLO



Material	AISI 304
Finishing	Brushed matte
Inner Corner	R 10 mm Welded
Overall dimensions	740 x 440 mm
Basin dimensions	700 x 400 mm
Bowl depth	200 mm
Black strainer	3 1/2"
Cabinet size	800 mm

Top mount  
Flush mount  
Under mount

Cod. **BI 7040 RH**

Cod. **BG 7040 RH**

Cod. **BO 7040 RH**

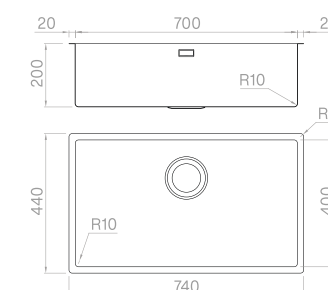

Accessories on page 117

RADIUS MATTE VINTAGE 50

READY



Slanted colander  
Ergo Tap

24  
41

- Top mount
- Flush mount
- Under mount

Cod. **SAB I 50 RH**  
Cod. **SABG 50 RH**  
Cod. **SABO 50 RH**

RADIUS MATTE VINTAGE 50

PRO



Slanted colander

24

- Top mount
- Flush mount
- Under mount

Cod. **SBB I 50 RH**  
Cod. **SBBG 50 RH**  
Cod. **SBBO 50 RH**

RADIUS MATTE VINTAGE 50

SOLO



Material	AISI 304
Finishing	Brushed matte
Inner Corner	R 10 mm Welded
Overall dimensions	540 x 440 mm
Basin dimensions	500 x 400 mm
Bowl depth	200 mm
Black strainer	3 ½"
Cabinet size	600 mm

- Top mount Cod. **BI 5040 RH**
- Flush mount Cod. **BG 5040 RH**
- Under mount Cod. **BO 5040 RH**

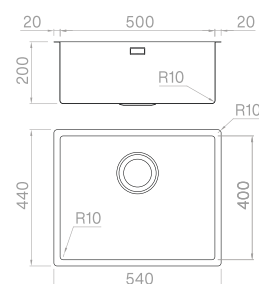

Accessories on page 117

RADIUS MATTE VINTAGE 40

READY



Slanted colander  
Ergo Tap

24  
41

- Top mount
- Flush mount
- Under mount

Cod. **SAB I 40 RH**  
Cod. **SABG 40 RH**  
Cod. **SABO 40 RH**

RADIUS MATTE VINTAGE 40

PRO



Slanted colander

24

- Top mount
- Flush mount
- Under mount

Cod. **SBB I 40 RH**  
Cod. **SBBG 40 RH**  
Cod. **SBBO 40 RH**

RADIUS MATTE VINTAGE 40

SOLO



Material	AISI 304
Finishing	Brushed matte
Inner Corner	R 10 mm Welded
Overall dimensions	440 x 440 mm
Basin dimensions	400 x 400 mm
Bowl depth	200 mm
Black strainer	3 ½"
Cabinet size	600 mm

- Top mount Cod. **BI 4040 RH**
- Flush mount Cod. **BG 4040 RH**
- Under mount Cod. **BO 4040 RH**

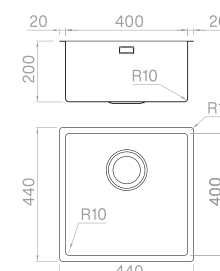

Accessories on page 117

Oak wood chopping board

3

300x420x20 mm  
Cod. **TRIB 3042**

PaperStone® chopping board

73

200x420x19 mm  
Cod. **TRPS 2042**

PaperStone® chopping board

54

300x420x20 mm  
Cod. **TRPS 3042**

Grid mat vintage

13

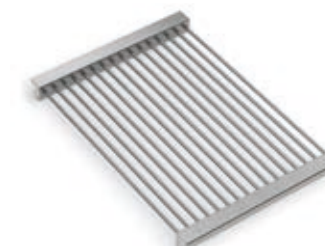
250x420x25 mm  
Cod. **GRH 2542**Slanted colander  
matte vintage

24

280x420x110/60 mm  
Cod. **VQHI 2842**

PaperStone® Slicer/grater set

75

200x420x20 mm  
Cod. **TI 2442 GP**

PaperStone® Gastronorm set

76

200x420x20 mm  
Cod. **TI 2442 VP**

PaperStone® Strainer set

77

200x420x20 mm  
Cod. **TI 2442 SP**

# RADIUS

The Radius collection offers a wide range of sink models, crafted with 10 mm internal radius corners. In this collection precision meets essential geometries.





## RADIUS 81 READY



- Wooden chopping board
- Slanted colander
- Basin
- Element Tap



3  
23  
26  
40

-  Top mount Cod. **SAB I 81 R1**
-  Flush mount Cod. **SABG 81 R1**
-  Under mount Cod. **SABO 81 R1**

## RADIUS 81 PRO





- Colander 16

-  Top mount Cod. **SBB I 81 R1**
-  Flush mount Cod. **SBBG 81 R1**
-  Under mount Cod. **SBBO 81 R1**

## RADIUS 81 SOLO



- Material AISI 304
- Finishing Brushed
- Inner Corner R 10 mm Welded
- Overall dimensions 850 x 440 mm
- Basin dimensions 810 x 400 mm
- Bowl depth 200 mm
- Standard strainer 3 1/2"
- Cabinet size 900 mm

-  Top mount Cod. **BI 8140 R1**
-  Flush mount Cod. **BG 8140 R1**
-  Under mount Cod. **BO 8140 R1**

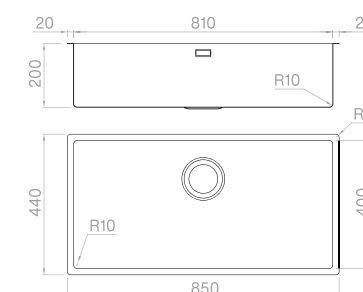

Accessories on page 127

## RADIUS 70 READY



Wooden chopping board  
Slanted colander  
Basin  
Element Tap

3  
23  
26  
40

Top mount  
Flush mount  
Under mount

Cod. **SAB I 70 R1**  
Cod. **SABG 70 R1**  
Cod. **SABO 70 R1**

## RADIUS 70 PRO



Colander

16

Top mount  
Flush mount  
Under mount

Cod. **SBB I 70 R1**  
Cod. **SBBG 70 R1**  
Cod. **SBBO 70 R1**

## RADIUS 70 SOLO



Material	AISI 304
Finishing	Brushed
Inner Corner	R 10 mm Welded
Overall dimensions	740 x 440 mm
Basin dimensions	700 x 400 mm
Bowl depth	200 mm
Standard strainer	3 ½"
Cabinet size	800 mm

Top mount  
Flush mount  
Under mount

Cod. **BI 7040 R1**  
Cod. **BG 7040 R1**  
Cod. **BO 7040 R1**

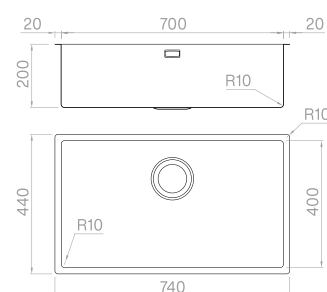

Accessories on page 127

## RADIUS 65 READY



Wooden chopping board  
Slanted colander  
Hero Tap

3  
23  
39

Top mount  
Flush mount  
Under mount

Cod. **SAB I 65 R1**  
Cod. **SABG 65 R1**  
Cod. **SABO 65 R1**

## RADIUS 65 PRO



Colander

16

Top mount  
Flush mount  
Under mount

Cod. **SBB I 65 R1**  
Cod. **SBBG 65 R1**  
Cod. **SBBO 65 R1**

## RADIUS 65 SOLO



Material	AISI 304
Finishing	Brushed
Inner Corner	R 10 mm Welded
Overall dimensions	690 x 440 mm
Basin dimensions	650 x 400 mm
Bowl depth	200 mm
Standard strainer	3 ½"
Cabinet size	750 mm

Top mount  
Flush mount  
Under mount

Cod. **BI 6540 R1**  
Cod. **BG 6540 R1**  
Cod. **BO 6540 R1**

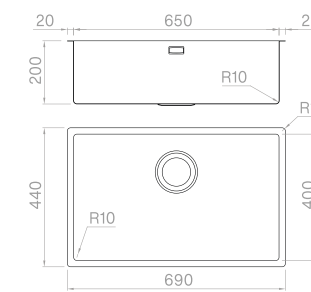

Accessories on page 127

## RADIUS 55

## READY

Wooden chopping board  
Slanted colander  
Hero Tap

3  
23  
39



Top mount  
Flush mount  
Under mount

Cod. **SAB I 55 R1**  
Cod. **SABG 55 R1**  
Cod. **SABO 55 R1**

## RADIUS 50

## READY

Wooden chopping board  
Slanted colander  
Hero Tap

3  
23  
39



Top mount  
Flush mount  
Under mount

Cod. **SAB I 50 R1**  
Cod. **SABG 50 R1**  
Cod. **SABO 50 R1**

## RADIUS 55

## PRO

Colander

16



Top mount  
Flush mount  
Under mount

Cod. **SBB I 55 R1**  
Cod. **SBBG 55 R1**  
Cod. **SBBO 55 R1**

## RADIUS 50

## PRO

Colander

16



Top mount  
Flush mount  
Under mount

Cod. **SBB I 50 R1**  
Cod. **SBBG 50 R1**  
Cod. **SBBO 50 R1**

## RADIUS 55

## SOLO

Material AISI 304  
Finishing Brushed  
Inner Corner R 10 mm Welded  
Overall dimensions 590 x 440 mm  
Basin dimensions 550 x 400 mm  
Bowl depth 200 mm  
Standard strainer 3 ½"  
Cabinet size 600 mm

Top mount  
Flush mount  
Under mount

Cod. **BI 5540 R1**  
Cod. **BG 5540 R1**  
Cod. **BO 5540 R1**

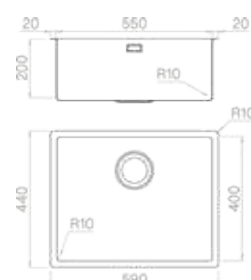

Accessories on page 127

## RADIUS 50

## SOLO

Material AISI 304  
Finishing Brushed  
Inner Corner R 10 mm Welded  
Overall dimensions 540 x 440 mm  
Basin dimensions 500 x 400 mm  
Bowl depth 200 mm  
Standard strainer 3 ½"  
Cabinet size 600 mm

Top mount  
Flush mount  
Under mount

Cod. **BI 5040 R1**  
Cod. **BG 5040 R1**  
Cod. **BO 5040 R1**

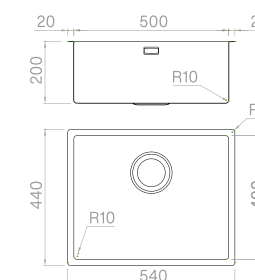

Accessories on page 127

**RADIUS 45** **READY**

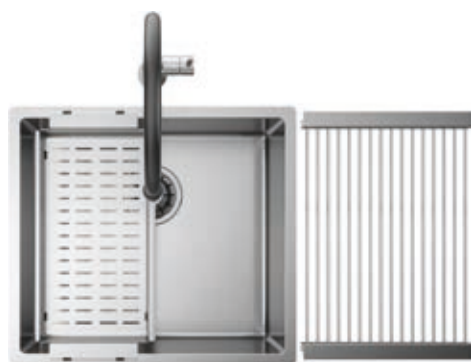

- Grid **12**
- Colander **16**
- Hero Tap **39**

- Top mount Cod. **SAB I 45 R1**
- Flush mount Cod. **SABG 45 R1**
- Under mount Cod. **SABO 45 R1**

**RADIUS 40 + 34** **READY**

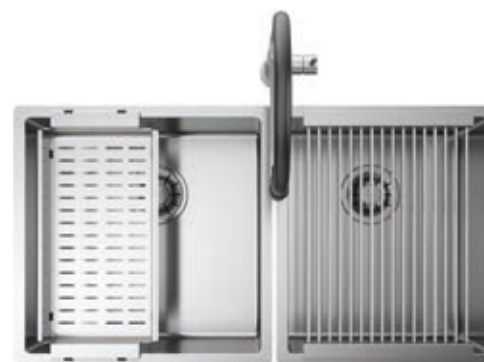

- Grid **12**
- Colander **16**
- Hero Tap **39**

- Top mount Cod. **SAB I 40 R1**
- Flush mount Cod. **SABG 40 R1**
- Under mount Cod. **SABO 40 R1**

**RADIUS 45** **PRO**



- Colander **16**

- Top mount Cod. **SBB I 45 R1**
- Flush mount Cod. **SBBG 45 R1**
- Under mount Cod. **SBBO 45 R1**

**RADIUS 40** **PRO**



- Colander **16**

- Top mount Cod. **SBB I 40 R1**
- Flush mount Cod. **SBBG 40 R1**
- Under mount Cod. **SBBO 40 R1**

**RADIUS 45** **SOLO**



- Material AISI 304
- Finishing Brushed
- Inner Corner R 10 mm Welded
- Overall dimensions 490 x 440 mm
- Basin dimensions 450 x 400 mm
- Bowl depth 200 mm
- Standard strainer 3 ½"
- Cabinet size 600 mm

- Top mount Cod. **BI 4540 R1**
- Flush mount Cod. **BG 4540 R1**
- Under mount Cod. **BO 4540 R1**

**RADIUS 40** **SOLO**



- Material AISI 304
- Finishing Brushed
- Inner Corner R 10 mm Welded
- Overall dimensions 440 x 440 mm
- Basin dimensions 400 x 400 mm
- Bowl depth 200 mm
- Standard strainer 3 ½"
- Cabinet size 600 mm

- Top mount Cod. **BI 4040 R1**
- Flush mount Cod. **BG 4040 R1**
- Under mount Cod. **BO 4040 R1**

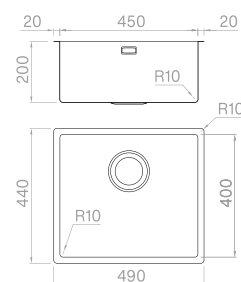

Accessories on page 127

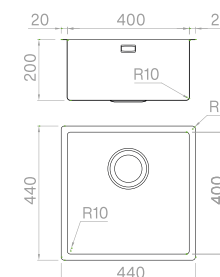

Accessories on page 127

## RADIUS 34+34

READY

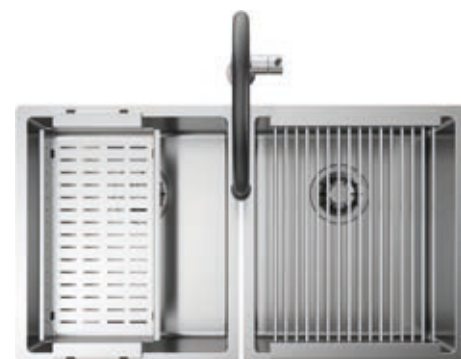

Grid  
Colander  
Hero Tap

12  
16  
39

Top mount  
Flush mount  
Under mount

Cod. **SAB I 34 R1**  
Cod. **SABG 34 R1**  
Cod. **SABO 34 R1**

## RADIUS 34

PRO



Colander

16

Top mount  
Flush mount  
Under mount

Cod. **SBB I 34 R1**  
Cod. **SBBG 34 R1**  
Cod. **SBBO 34 R1**

## RADIUS 34

SOLO



Material	AISI 304
Finishing	Brushed
Inner Corner	R 10 mm Welded
Overall dimensions	380 x 440 mm
Basin dimensions	340 x 400 mm
Bowl depth	200 mm
Standard strainer	3 1/2"
Cabinet size	450 mm

Top mount  
Flush mount  
Under mount

Cod. **BI 3440 R1**  
Cod. **BG 3440 R1**  
Cod. **BO 3440 R1**

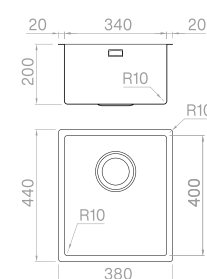

Accessories on page 127

## Oak wood chopping board

3

300x420x20 mm  
Cod. **TRIB 3042**



## HDPE chopping board

6

240x420x20 mm  
Cod. **TRP 2442**



## PaperStone® chopping board

54

300x420x20 mm  
Cod. **TRPS 3042**



## Grid

12

250x420x25 mm  
Cod. **GRS 2542**



## Colander

16

210x420x60 mm  
Cod. **VQSF 2142**

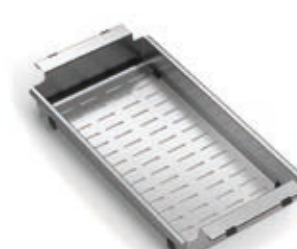

## Slanted colander

23

280x420x110/60 mm  
Cod. **VQSI 2842**



## Basin

26

280x420x160 mm  
Cod. **VQSP 2842**



## PaperStone® Gastronorm set

76

200x420x20 mm  
Cod. **TI 2442 VP**



## PaperStone® Strainer set

77

200x420x20 mm  
Cod. **TI 2442 SP**



## PaperStone® Slicer/grater set

75

200x420x20 mm  
Cod. **TI 2442 GP**



## Plate holder

36

250x420x55 mm  
Cod. **PPPB V400**



## Drainer tray

61

340x420x30 mm  
Cod. **VQSI 3442**

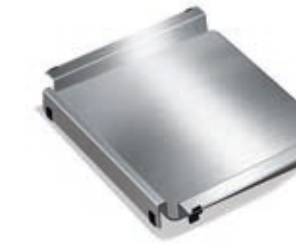



## PRISMA

A perfect combination of geometrical precision and clean aesthetic. In this collection the zero-radius vertical corners join onto an exclusive 45° inclined bottom perimeter.



## PRISMA 81

## READY



Wooden chopping board  
Slanted colander  
Basin  
Element Tap

3  
23  
26  
40

 Top mount  
 Flush mount  
 Under mount

Cod. **SAPR I 81**  
Cod. **SAPRG 81**  
Cod. **SAPRO 81**

## PRISMA 81

## PRO



Colander

16

 Top mount  
 Flush mount  
 Under mount

Cod. **SBPR I 81**  
Cod. **SBPRG 81**  
Cod. **SBPRO 81**

## PRISMA 81

## SOLO



Material AISI 304  
Finishing Brushed  
Inner Corner R 0 mm Welded  
Overall dimensions 850 x 440 mm  
Basin dimensions 810 x 400 mm  
Bowl depth 200 mm  
Standard strainer 3 1/2"  
Cabinet size 900 mm

 Top mount  
 Flush mount  
 Under mount

Cod. **PR I 81**  
Cod. **PR G 81**  
Cod. **PR O 81**

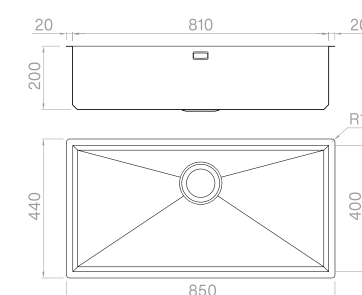

Accessories on page 139



**PRISMA 70** **READY**



- Wooden chopping board
- Slanted colander
- Basin
- Element Tap

- 3
- 23
- 26
- 40

- Top mount
- Flush mount
- Under mount

- Cod. **SAPR I 70**
- Cod. **SAPRG 70**
- Cod. **SAPRO 70**

**PRISMA 70** **PRO**



- Colander

- 16

- Top mount
- Flush mount
- Under mount

- Cod. **SBPR I 70**
- Cod. **SBPRG 70**
- Cod. **SBPRO 70**

**PRISMA 70** **SOLO**



- Material: AISI 304
- Finishing: Brushed
- Inner Corner: R 0 mm Welded
- Overall dimensions: 740 x 440 mm
- Basin dimensions: 700 x 400 mm
- Bowl depth: 200 mm
- Standard strainer: 3 ½"
- Cabinet size: 800 mm

- Top mount
- Flush mount
- Under mount

- Cod. **PR I 70**
- Cod. **PR G 70**
- Cod. **PR O 70**

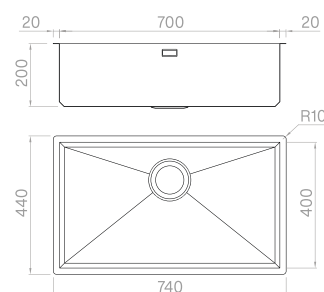

Accessories on page 139

**PRISMA 65** **READY**



- Wooden chopping board
- Slanted colander
- Vertigo Tap

- 3
- 23
- 47

- Top mount
- Flush mount
- Under mount

- Cod. **SAPR I 65**
- Cod. **SAPRG 65**
- Cod. **SAPRO 65**

**PRISMA 65** **PRO**



- Colander

- 16

- Top mount
- Flush mount
- Under mount

- Cod. **SBPR I 65**
- Cod. **SBPRG 65**
- Cod. **SBPRO 65**

**PRISMA 65** **SOLO**



- Material: AISI 304
- Finishing: Brushed
- Inner Corner: R 0 mm Welded
- Overall dimensions: 690 x 440 mm
- Basin dimensions: 650 x 400 mm
- Bowl depth: 200 mm
- Standard strainer: 3 ½"
- Cabinet size: 750 mm

- Top mount
- Flush mount
- Under mount

- Cod. **PR I 65**
- Cod. **PR G 65**
- Cod. **PR O 65**

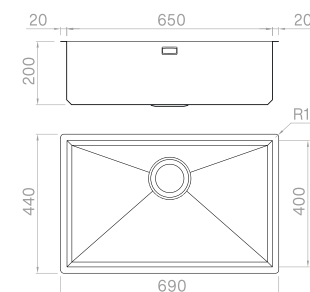

Accessories on page 139

**PRISMA 50** **READY**



- Wooden chopping board
- Slanted colander
- Vertigo Tap

3  
23  
47

- Top mount
- Flush mount
- Under mount

Cod. **SAPR I 50**  
Cod. **SAPRG 50**  
Cod. **SAPRO 50**

**PRISMA 50** **PRO**



- Colander

16

- Top mount
- Flush mount
- Under mount

Cod. **SBPR I 50**  
Cod. **SBPRG 50**  
Cod. **SBPRO 50**

**PRISMA 50** **SOLO**



- Material: AISI 304
- Finishing: Brushed
- Inner Corner: R 0 mm Welded
- Overall dimensions: 540 x 440 mm
- Basin dimensions: 500 x 400 mm
- Bowl depth: 200 mm
- Standard strainer: 3 1/2"
- Cabinet size: 600 mm

- Top mount
- Flush mount
- Under mount

Cod. **PR I 50**  
Cod. **PR G 50**  
Cod. **PR O 50**

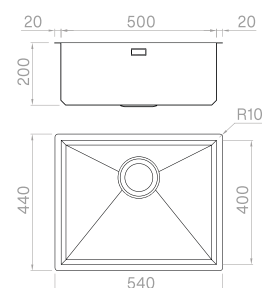

Accessories on page 139

**PRISMA 45** **READY**

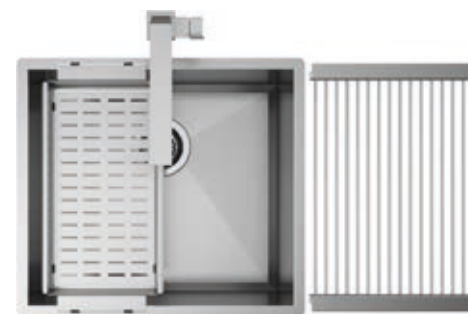

- Grid
- Colander
- Vertigo Tap

12  
16  
47

- Top mount
- Flush mount
- Under mount

Cod. **SAPR I 45**  
Cod. **SAPRG 45**  
Cod. **SAPRO 45**

**PRISMA 45** **PRO**



- Colander

16

- Top mount
- Flush mount
- Under mount

Cod. **SBPR I 45**  
Cod. **SBPRG 45**  
Cod. **SBPRO 45**

**PRISMA 45** **SOLO**



- Material: AISI 304
- Finishing: Brushed
- Inner Corner: R 0 mm Welded
- Overall dimensions: 490 x 440 mm
- Basin dimensions: 450 x 400 mm
- Bowl depth: 200 mm
- Standard strainer: 3 1/2"
- Cabinet size: 600 mm

- Top mount
- Flush mount
- Under mount

Cod. **PR I 45**  
Cod. **PR G 45**  
Cod. **PR O 45**

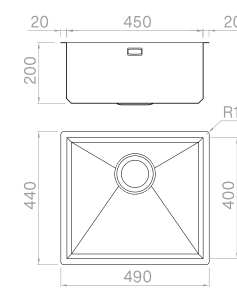

Accessories on page 139

**PRISMA 40 + 34** **READY**

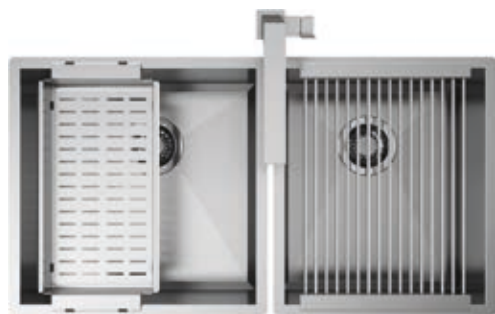

- Grid **12**
- Colander **16**
- Vertigo Tap **47**

- Top mount Cod. **SAPR I 40**
- Flush mount Cod. **SAPRG 40**
- Under mount Cod. **SAPRO 40**

**PRISMA 34 + 34** **READY**

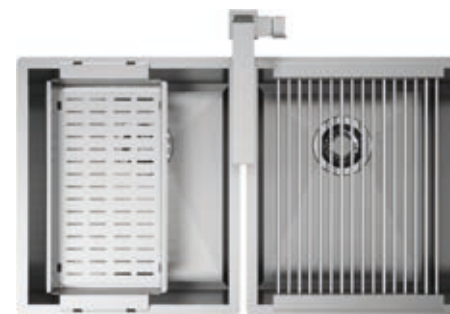

- Grid **12**
- Colander **16**
- Vertigo Tap **47**

- Top mount Cod. **SAPR I 34**
- Flush mount Cod. **SAPRG 34**
- Under mount Cod. **SAPRO 34**

**PRISMA 40** **PRO**



- Colander **16**

- Top mount Cod. **SBPR I 40**
- Flush mount Cod. **SBPRG 40**
- Under mount Cod. **SBPRO 40**

**PRISMA 34** **PRO**



- Colander **16**

- Top mount Cod. **SBPR I 34**
- Flush mount Cod. **SBPRG 34**
- Under mount Cod. **SBPRO 34**

**PRISMA 40** **SOLO**



- Material AISI 304
- Finishing Brushed
- Inner Corner R 0 mm Welded
- Overall dimensions 440 x 440 mm
- Basin dimensions 400 x 400 mm
- Bowl depth 200 mm
- Standard strainer 3 ½"
- Cabinet size 600 mm

- Top mount Cod. **PR I 40**
- Flush mount Cod. **PR G 40**
- Under mount Cod. **PR O 40**

**PRISMA 34** **SOLO**



- Material AISI 304
- Finishing Brushed
- Inner Corner R 0 mm Welded
- Overall dimensions 380 x 440 mm
- Basin dimensions 340 x 400 mm
- Bowl depth 200 mm
- Standard strainer 3 ½"
- Cabinet size 450 mm

- Top mount Cod. **PR I 34**
- Flush mount Cod. **PR G 34**
- Under mount Cod. **PR O 34**

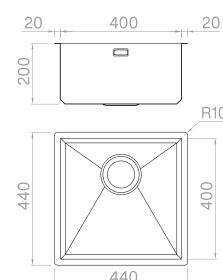

Accessories on page 139

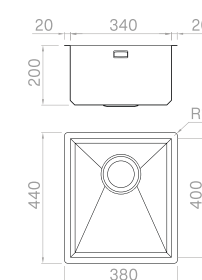

Accessories on page 139

Oak wood chopping board

3

300x420x20 mm

Cod. **TRIB 3042**

HDPE chopping board

6

240x420x20 mm

Cod. **TRP 2442**

PaperStone® chopping board

54

300x420x20 mm

Cod. **TRPS 3042**

Grid

12

250x420x25 mm

Cod. **GRS 2542**

Colander

16

210x420x60 mm

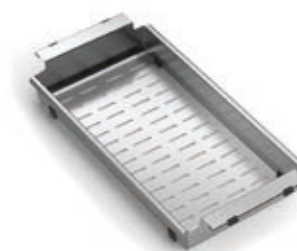
Cod. **VQSF 2142**

Slanted colander

23

280x420x110/60 mm

Cod. **VQSI 2842**

Basin

26

280x420x160 mm

Cod. **VQSP 2842**

Gastronorm set

30

240x420x100 mm

Cod. **TI 2442 V**

Strainer set

32

240x420x100 mm

Cod. **TI 2442 1S**

Slicer/grater set

34

200x420x70 mm

Cod. **TI 2442 PG**

Plate holder

36

250x420x55 mm

Cod. **PPPB V400**

Drainer tray

61

340x420x30 mm

Cod. **VQSI 3442**

# GHOST

The Ghost concept features an incorporated lowering level, allowing for the placement of the mixer within the basin area: a brilliant and top-quality concealing solution in a contained space.



## GHOST 60

## READY

PaperStone® chopping board  
Circle Tap

73  
45



Top mount  
Flush mount  
Under mount

Cod. **SAG I 60 RM**  
Cod. **SAGF 60 RM**  
Cod. **SAGO 60 RM**

## GHOST 60

## PRO

Circle Tap

45



Top mount  
Flush mount  
Under mount

Cod. **SBG I 60 RM**  
Cod. **SBGF 60 RM**  
Cod. **SBGO 60 RM**

## GHOST 60

## SOLO

Material AISI 304  
Finishing Brushed  
Inner Corner R 10 mm Welded  
Overall dimensions 440 x 520 mm  
Basin dimensions 400 x 400 + 80 mm  
Bowl depth 65/200 mm  
Plus Strainer 3 ½"  
Cabinet size 600 mm



Top mount  
Flush mount  
Under mount

Cod. **SIG 60 RM**  
Cod. **SFG 60 RM**  
Cod. **SSG 60 RM**

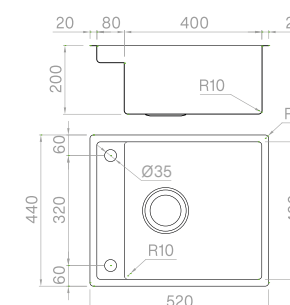

Accessories on page 143



Oak wood chopping board

3

300x420x20 mm  
Cod. **TRIB 3042**

HDPE chopping board

6

240x420x20 mm  
Cod. **TRP 2442**

Colander

16

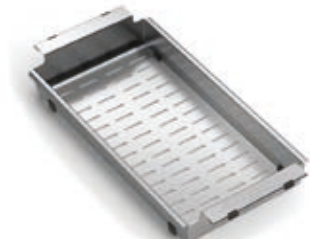
210x420x60 mm  
Cod. **VQSF 2142**

Grid

12

250x420x25 mm  
Cod. **GRS 2542**

PaperStone® chopping board

73

200x420x19 mm  
Cod. **TRPS 2042**

Gastronorm set

30

240x420x100 mm  
Cod. **TI 2442 V**

Strainer set

32

240x420x100 mm  
Cod. **TI 2442 1S**

Slicer/grater set

34

200x420x70 mm  
Cod. **TI 2442 PG**

Plate holder

36

250x420x55 mm  
Cod. **PPPB V400**

PaperStone® Gastronorm set

76

200x420x20 mm  
Cod. **TI 2442 VP**

PaperStone® Strainer set

77

200x420x20 mm  
Cod. **TI 2442 SP**

PaperStone® Slicer/grater set

75

200x420x20 mm  
Cod. **TI 2442 GP**

# MOSE

The Mose collection is characterized by double-basin sinks with a lowered bridge. Accessories can slide across the entire length. Also available with an integrated mixer area extension.



## MOSE SB 81 READY



Wooden chopping board  
Colander  
Hero Tap

3  
16  
39

Top mount  
Flush mount  
Under mount

Cod. **SAM I 81 R1**  
Cod. **SAMG 81 R1**  
Cod. **SAMO 81 R1**

## MOSE SB 81 PRO



Colander

16

Top mount  
Flush mount  
Under mount

Cod. **SBM I 81 R1**  
Cod. **SBMG 81 R1**  
Cod. **SBMO 81 R1**

## MOSE SB 81 SOLO



Material AISI 304  
Finishing Brushed  
Inner Corner R 10 mm Welded  
Overall dimensions 810 x 440 mm  
Basin dimensions 400 x 400 mm / 340 x 400 mm  
Bowl depth 200 mm  
Standard strainer 3 ½"  
Cabinet size 900 mm

Top mount  
Flush mount  
Under mount

Cod. **MI 8140 R1**  
Cod. **MG 8140 R1**  
Cod. **MO 8140 R1**

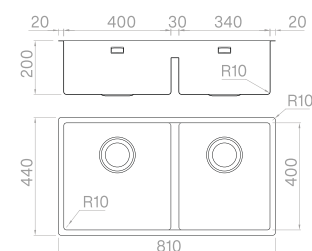

Accessories on page 151

## MOSE SB 60 READY



Wooden chopping board  
Colander  
Hero Tap

3  
16  
39

Top mount  
Flush mount  
Under mount

Cod. **SAM I 60 R1**  
Cod. **SAMG 60 R1**  
Cod. **SAMO 60 R1**

## MOSE SB 60 PRO



Colander

16

Top mount  
Flush mount  
Under mount

Cod. **SBM I 60 R1**  
Cod. **SBMG 60 R1**  
Cod. **SBMO 60 R1**

## MOSE SB 60 SOLO



Material AISI 304  
Finishing Brushed  
Inner Corner R 10 mm Welded  
Overall dimensions 590 x 440 mm  
Basin dimensions 180 x 400 mm / 340 x 400 mm  
Bowl depth 170 / 200 mm  
Standard strainer 3 ½"  
Cabinet size 600 mm

Top mount  
Flush mount  
Under mount

Cod. **MI 6040 R1**  
Cod. **MG 6040 R1**  
Cod. **MO 6040 R1**

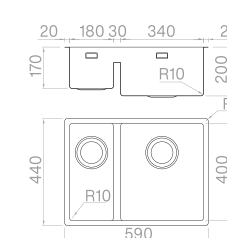

Accessories on page 151

**MOSE BR 81** **READY**



- Wooden chopping board
- Colander
- Hero Tap

3  
16  
39

- Top mount
- Flush mount

Cod. **SAM BR I 81**  
Cod. **SAM BRG 81**

**MOSE BR 81** **PRO**



- Colander

16

- Top mount
- Flush mount

Cod. **SBM BR I 81**  
Cod. **SBM BRG 81**

**MOSE BR 81** **SOLO**



- Material: AISI 304
- Finishing: Brushed
- Inner Corner: R 10 mm Welded
- Overall dimensions: 810 x 510 mm
- Basin dimensions: 400 x 400 mm / 340 x 400 mm
- Bowl depth: 200 mm
- Standard strainer: 3 ½"
- Cabinet size: 900 mm

- Top mount
- Flush mount

Cod. **ALM BR I 81**  
Cod. **ALM BRG 81**

Mixer hole: specify extra holes when ordering.

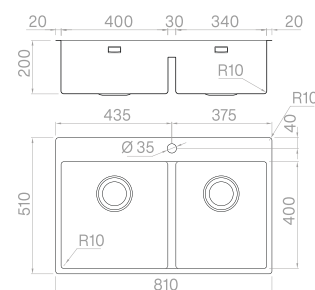

Accessories on page 151

**MOSE BR 60** **READY**



- Wooden chopping board
- Colander
- Hero Tap

3  
16  
39

- Top mount
- Flush mount

Cod. **SAM BR I 60**  
Cod. **SAM BRG 60**

**MOSE BR 60** **PRO**



- Colander

16

- Top mount
- Flush mount

Cod. **SBM BR I 60**  
Cod. **SBM BRG 60**

**MOSE BR 60** **SOLO**



- Material: AISI 304
- Finishing: Brushed
- Inner Corner: R 10 mm Welded
- Overall dimensions: 590 x 510 mm
- Basin dimensions: 180 x 400 mm / 340 x 400 mm
- Bowl depth: 170 / 200 mm
- Standard strainer: 3 ½"
- Cabinet size: 600 mm

- Top mount
- Flush mount

Cod. **ALM BR I 60**  
Cod. **ALM BRG 60**

Mixer hole: specify extra holes when ordering.

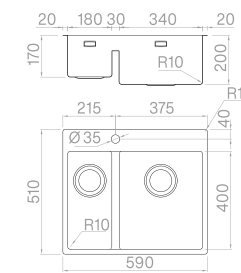

Accessories on page 151



Oak wood chopping board

3

300x420x20 mm

Cod. **TRIB 3042**



HDPE chopping board

6

240x420x20 mm

Cod. **TRP 2442**



PaperStone® chopping board

73

200x420x19 mm

Cod. **TRPS 2042**



PaperStone® chopping board

54

300x420x20 mm

Cod. **TRPS 3042**



Grid

12

250x420x25 mm

Cod. **GRS 2542**



Colander

16

210x420x60 mm

Cod. **VQSF 2142**



Plate holder

36

250x420x55 mm

Cod. **PPPB V400**



Drainer tray

61

340x420x30 mm

Cod. **VQSI 3442**



PaperStone® Gastronorm set

76

200x420x20 mm

Cod. **TI 2442 VP**



PaperStone® Strainer set

77

200x420x20 mm

Cod. **TI 2442 SP**



PaperStone® Slicer/grater set

75

200x420x20 mm

Cod. **TI 2442 GP**



NEWGO



# NEWGO MATTE VINTAGE

An elegant and sophisticated workstation which combines the Matte Vintage stainless steel finishing with the black finishing of the mixers and accessories.



## NEWGO 81 MATTE VINTAGE

READY



Grid matte vintage  
Slanted colander matte vintage  
Ergo Tap

13

24

41

Top mount  
Flush mount

Cod. **SAG I 81H**

Cod. **SAGG 81H**

## NEWGO 81 MATTE VINTAGE

PRO

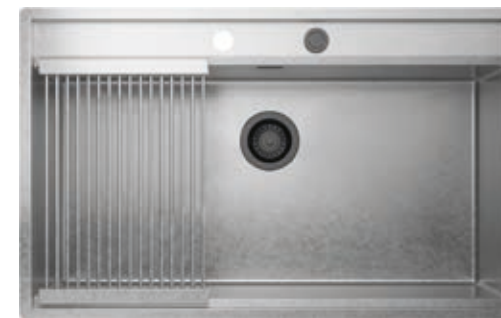

Grid matte vintage

13

Top mount  
Flush mount

Cod. **SBG I 81H**

Cod. **SBGG 81H**

## NEWGO 81 MATTE VINTAGE

SOLO



Material	AISI 304
Finishing	Brushed matte
Inner Corner	R 10 mm Welded
Overall dimensions	850 x 530 mm
Basin dimensions	810 x 400 mm
Bowl depth	220 mm
Automatic black pop-up drain system	3 1/2"
Cabinet size	900 mm

Top mount  
Flush mount

Cod. **ALG I 81H**

Cod. **ALGG 81H**

Mixer hole: specify extra holes when ordering.

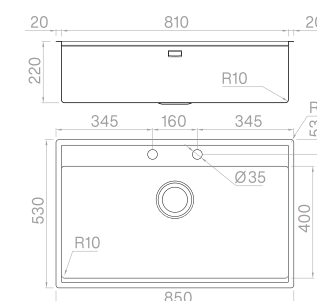

Accessories on page 157

**NEWGO 70 MATTE VINTAGE** **READY**



- Grid matte vintage
- Slanted colander matte vintage
- Ergo Tap

13  
24  
41

- Top mount
- Flush mount

Cod. **SAG I 70H**  
Cod. **SAGG 70H**

**NEWGO 70 MATTE VINTAGE** **PRO**



- Grid matte vintage

13

- Top mount
- Flush mount

Cod. **SBG I 70H**  
Cod. **SBGG 70H**

**NEWGO 70 MATTE VINTAGE** **SOLO**



- Material: AISI 304
- Finishing: Brushed matte
- Inner Corner: R 10 mm Welded
- Overall dimensions: 740 x 530 mm
- Basin dimensions: 700 x 400 mm
- Bowl depth: 220 mm
- Automatic black pop-up drain system: 3 1/2"
- Cabinet size: 800 mm

- Top mount
- Flush mount

Cod. **ALG I 70H**  
Cod. **ALGG 70H**

Mixer hole: specify extra holes when ordering.

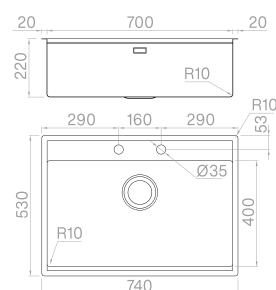

Accessories on page 157

**Oak wood chopping board**

3

300x420x20 mm  
Cod. **TRIB 3042**



**HDPE chopping board**

6

240x420x20 mm  
Cod. **TRP 2442**



**PaperStone® chopping board**

54

300x420x20 mm  
Cod. **TRPS 3042**



**Grid matte vintage**

13

250x420x25 mm  
Cod. **GRH 2542**

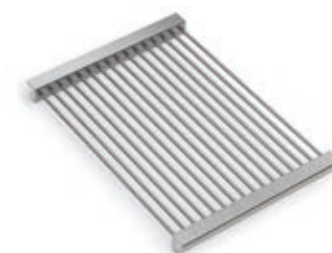

**Slanted colander matte vintage**

24

280x420x110/60 mm  
Cod. **VQHI 2842**



**PaperStone® Gastronorm set**

76

200x420x20 mm  
Cod. **TI 2442 VP**



**PaperStone® Strainer set**

77

200x420x20 mm  
Cod. **TI 2442 SP**



**PaperStone® Slicer/grater set**

75

200x420x20 mm  
Cod. **TI 2442 GP**



**Dish holder**

36

250x420x55 mm  
Cod. **PPPB V400**



# NEWGO

The increased depth and the lowering all around allows the housing of the mixer within the contained working area.



## NEWGO 81

## READY

Grid  
Slanted colander  
Circle Tap

12

23

45

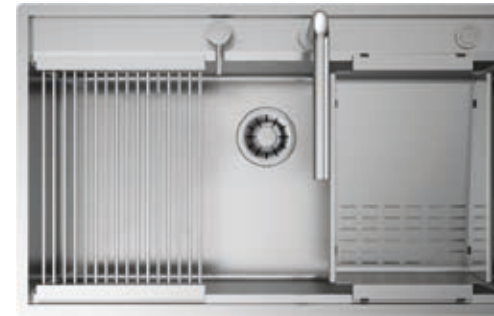

Top mount  
Flush mount

Cod. **SAG I 81**Cod. **SAGG 81**

## NEWGO 81

## PRO

Grid

12



Top mount  
Flush mount

Cod. **SBG I 81**Cod. **SBGG 81**

## NEWGO 81

## SOLO

Material	AISI 304
Finishing	Brushed
Inner Corner	R 10 mm Welded
Overall dimensions	850 x 530 mm
Basin dimensions	810 x 400 mm
Bowl depth	220 mm
Automatic pop-up drain system	3 1/2"
Cabinet size	900 mm



Top mount  
Flush mount

Cod. **ALG I 81**Cod. **ALGG 81**

Mixer hole: specify extra holes when ordering.

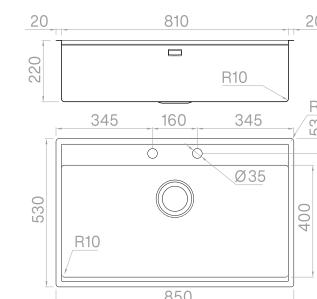

Accessories on page 161

**NEWGO 70** **READY**



- Grid **12**
- Slanted colander **23**
- Circle Tap **45**

- Top mount Cod. **SAG I 70**
- Flush mount Cod. **SAGG 70**

**NEWGO 70** **PRO**



- Grid **12**

- Top mount Cod. **SBG I 70**
- Flush mount Cod. **SBGG 70**

**NEWGO 70** **SOLO**



- Material AISI 304
- Finishing Brushed
- Inner Corner R 10 mm Welded
- Overall dimensions 740 x 530 mm
- Basin dimensions 700 x 400 mm
- Bowl depth 220 mm
- Automatic pop-up drain system 3 1/2"
- Cabinet size 800 mm

- Top mount Cod. **ALG I 70**
- Flush mount Cod. **ALGG 70**

Mixer hole: specify extra holes when ordering.

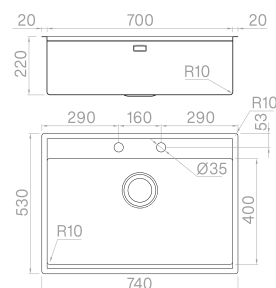

Accessories on page 161

**Oak wood chopping board** **3**  
300x420x20 mm  
Cod. **TRIB 3042**



**HDPE chopping board** **6**  
240x420x20 mm  
Cod. **TRP 2442**



**Grid** **12**  
250x420x25 mm  
Cod. **GRS 2542**



**Set Colander** **16**  
210x420x60 mm  
Cod. **VQSF 2142**

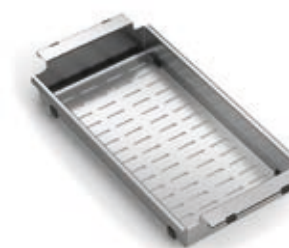

**Slanted colander** **23**  
280x420x110/60 mm  
Cod. **VQSI 2842**



**Basin** **26**  
280x420x160 mm  
Cod. **VQSP 2842**



**PaperStone® Gastronorm set** **76**  
200x420x20 mm  
Cod. **TI 2442 VP**



**PaperStone® Strainer set** **77**  
200x420x20 mm  
Cod. **TI 2442 SP**



**PaperStone® Slicer/grater set** **75**  
200x420x20 mm  
Cod. **TI 2442 GP**



**Dish holder** **36**  
250x420x55 mm  
Cod. **PPPB V400**



**PaperStone® chopping board** **54**  
300x420x20 mm  
Cod. **TRPS 3042**



**Drainer tray** **61**  
340x420x30 mm  
Cod. **VQSI 3442**



# AQUA

Aqua is a collection characterized by a large capacity and an essential design determined by the 10 mm radius corner all round and an integrated mixer housing extension part of the working area.



**AQUA 81** **READY**



- Wooden chopping board **3**
- Colander **16**
- Hero Tap **39**

- Top mount Cod. **SAA I 81**
- Flush mount Cod. **SAAG 81**

**AQUA 70** **READY**



- Wooden chopping board **3**
- Colander **16**
- Hero Tap **39**

- Top mount Cod. **SAA I 70**
- Flush mount Cod. **SAAG 70**

**AQUA 81** **PRO**



- Colander **16**

- Top mount Cod. **SBA I 81**
- Flush mount Cod. **SBAG 81**

**AQUA 70** **PRO**



- Colander **16**

- Top mount Cod. **SBA I 70**
- Flush mount Cod. **SBAG 70**

**AQUA 81** **SOLO**



- Material AISI 304
- Finishing Brushed
- Inner Corner R 10 mm Welded
- Overall dimensions 850 x 510 mm
- Basin dimensions 810 x 400 mm
- Bowl depth 200 mm
- Standard strainer 3 ½"
- Cabinet size 900 mm

- Top mount Cod. **ALA I 81**
- Flush mount Cod. **ALAG 81**

**AQUA 70** **SOLO**



- Material AISI 304
- Finishing Brushed
- Inner Corner R 10 mm Welded
- Overall dimensions 740 x 510 mm
- Basin dimensions 700 x 400 mm
- Bowl depth 200 mm
- Standard strainer 3 ½"
- Cabinet size 800 mm

- Top mount Cod. **ALA I 70**
- Flush mount Cod. **ALAG 70**

Mixer hole: specify extra holes when ordering.

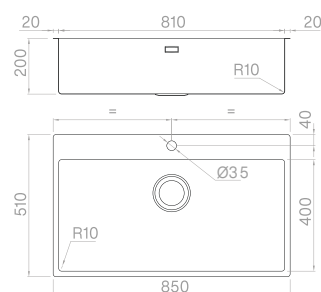

Accessories on page 169

Mixer hole: specify extra holes when ordering.

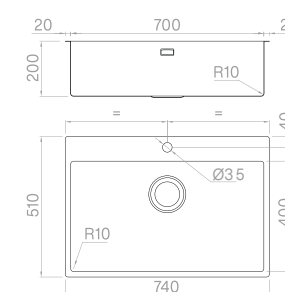

Accessories on page 169

**AQUA 65** **READY**



- Wooden chopping board
- Colander
- Hero Tap

3  
16  
39

- Top mount
- Flush mount

Cod. **SAA I 65**  
Cod. **SAAG 65**

**AQUA 65** **PRO**



- Colander

16

- Top mount
- Flush mount

Cod. **SBA I 65**  
Cod. **SBAG 65**

**AQUA 65** **SOLO**



- Material: AISI 304
- Finishing: Brushed
- Inner Corner: R 10 mm Welded
- Overall dimensions: 690 x 510 mm
- Basin dimensions: 650 x 400 mm
- Bowl depth: 200 mm
- Standard strainer: 3 1/2"
- Cabinet size: 750 mm

- Top mount
- Flush mount

Cod. **ALA I 65**  
Cod. **ALAG 65**

Mixer hole: specify extra holes when ordering.

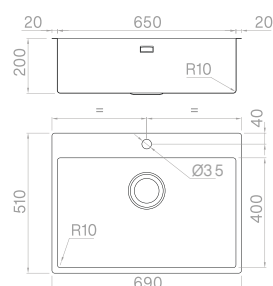

Accessories on page 169

**AQUA 50** **READY**



- Wooden chopping board
- Colander
- Hero Tap

3  
16  
39

- Top mount
- Flush mount

Cod. **SAA I 50**  
Cod. **SAAG 50**

**AQUA 50** **PRO**



- Colander

16

- Top mount
- Flush mount

Cod. **SBA I 50**  
Cod. **SBAG 50**

**AQUA 50** **SOLO**



- Material: AISI 304
- Finishing: Brushed
- Inner Corner: R 10 mm Welded
- Overall dimensions: 540 x 510 mm
- Basin dimensions: 500 x 400 mm
- Bowl depth: 200 mm
- Standard strainer: 3 1/2"
- Cabinet size: 600 mm

- Top mount
- Flush mount

Cod. **ALA I 50**  
Cod. **ALAG 50**

Mixer hole: specify extra holes when ordering.

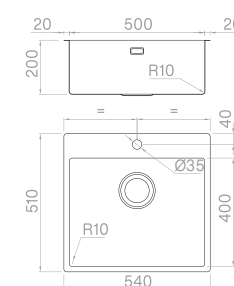

Accessories on page 169



Oak wood chopping board

3

300x420x20 mm

Cod. **TRIB 3042**

HDPE chopping board

6

240x420x20 mm

Cod. **TRP 2442**

PaperStone® chopping board

54

300x420x20 mm

Cod. **TRPS 3042**

Grid

12

250x420x25 mm

Cod. **GRS 2542**

Colander

16

210x420x60 mm

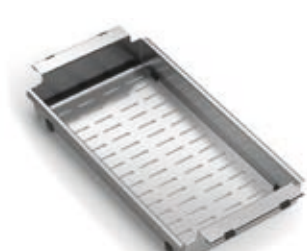
Cod. **VQSF 2142**

Slanted colander

23

280x420x110/60 mm

Cod. **VQSI 2842**

Basin

26

280x420x160 mm

Cod. **VQSP 2842**

Gastronorm set

30

240x420x100 mm

Cod. **TI 2442 V**

Strainer set

32

240x420x100 mm

Cod. **TI 2442 1S**

Slicer/grater set

34

200x420x70 mm

Cod. **TI 2442 PG**

Plate holder

36

250x420x55 mm

Cod. **PPPB V400**

Drainer tray

61

340x420x30 mm

Cod. **VQSI 3442**



OUTDOOR

# STARTAC MARINA

The kitchen expands into new outdoor spaces. Made of stainless steel AISI 316 L, Startac is designed to provide the same functionality and hygiene in the outdoor. Coming with a built-in cover, once closed, Startac discretely becomes one with the worktop.







STARTAC MARINA 55

READY



Colander  
Circle Steel Tap

58  
52

Top mount

Cod. **SAMC 55**

STARTAC MARINA 55

PRO



Circle Steel Tap

52

Top mount

Cod. **SBMC 55**

STARTAC MARINA 55

SOLO



Material	AISI 316 L
Finishing	Brushed
Inner corners	R 10 mm welded
Overall dimensions	590 x 510 mm
Basin dimensions	550 x 350 mm
Bowl depth	240 mm
Plus Strainer	3 1/2"
Cabinet size	600 mm

Top mount

Cod. **MC 55**

Under mount

Cod. **MC 55G**

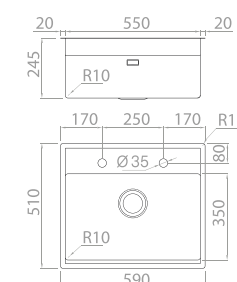

Accessories on page 186

# GHOST MARINA

Made in premium quality AISI 316 L stainless steel, this brilliant solution is the ideal choice when space is limited. The lowering of the mixer docking area allows to conceal the mixer within the basins volume.



## GHOST MARINA 60

### READY

PaperStone® chopping board  
Circle Steel Tap

73

52



Top mount  
Under mount

Cod. **SAGO 60 MG**

Cod. **SAGS 60 MG**

## GHOST MARINA 60

### PRO

Circle Steel Tap

52



Top mount  
Under mount

Cod. **SBGO 60 MG**

Cod. **SBGS 60 MG**

## GHOST MARINA 60

### SOLO

Material	AISI 316 L
Finishing	Brushed
Inner corners	R 10 mm welded
Overall dimensions	440 x 520 mm
Basin dimensions	400 x 400 + 80 mm
Bowl depth	65 / 200 mm
Plus Strainer	3 ½"
Cabinet size	600 mm



Top mount  
Under mount

Cod. **SIG 60 MG**

Cod. **SSG 60 MG**

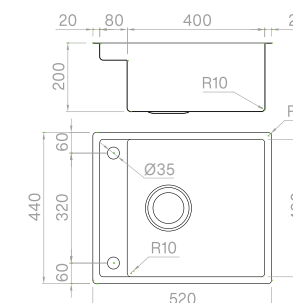

Accessories on page 186

# RADIUS MARINA



This range is characterized by the chemical composition of AISI 316 L. This stainless-steel alloy is more resistant to corrosion and oxidation, making it a more suitable choice for the outdoor use, especially in saline environments.



## RADIUS MARINA 70 READY





- PaperStone® chopping board **54**
- Slanted colander **51**
- Circle Steel Tap **52**

-  Top mount Cod. **SABI 70 MR**
-  Flush mount Cod. **SABG 70 MR**
-  Under mount Cod. **SABO 70 MR**

## RADIUS MARINA 70 PRO





- Colander **50**

-  Top mount Cod. **SBBI 70 MR**
-  Flush mount Cod. **SBBG 70 MR**
-  Under mount Cod. **SBBO 70 MR**

## RADIUS MARINA 70 SOLO



- Material AISI 316 L
- Finishing Brushed
- Inner corners R 10 mm welded
- Overall dimensions 740 x 530 mm
- Basin dimensions 700 x 400 mm
- Bowl depth 220 mm
- Standard Strainer 3 1/2"
- Cabinet size 800 mm

-  Top mount Cod. **BI 7040 MR**
-  Flush mount Cod. **BG 7040 MR**
-  Under mount Cod. **BO 7040 MR**

Accessories on page 186

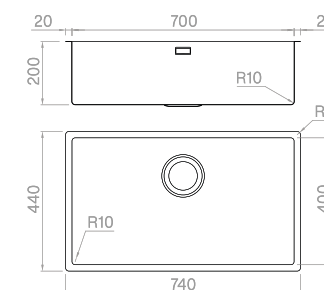

RADIUS MARINA 50

READY



- PaperStone® chopping board
- Slanted colander
- Circle Steel Tap

54  
51  
52

- Top mount
- Flush mount
- Under mount

Cod. **SABI 50 MR**  
Cod. **SABG 50 MR**  
Cod. **SABO 50 MR**

RADIUS MARINA 50

PRO



- Colander

50

- Top mount
- Flush mount
- Under mount

Cod. **SBBI 50 MR**  
Cod. **SBBG 50 MR**  
Cod. **SBBO 50 MR**

RADIUS MARINA 50

SOLO



- Material AISI 316 L
- Finishing Brushed
- Inner corners R 10 mm welded
- Overall dimensions 540 x 440 mm
- Basin dimensions 500 x 400 mm
- Bowl depth 200 mm
- Standard Strainer 3 ½"
- Cabinet size 600 mm

- Top mount
- Flush mount
- Under mount

Cod. **BI 5040 MR**  
Cod. **BG 5040 MR**  
Cod. **BO 5040 MR**

Accessories on page 186

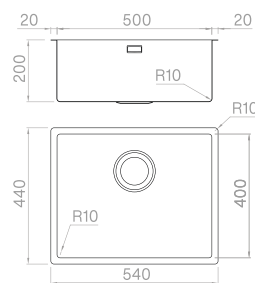

RADIUS MARINA 45

READY



- PaperStone® chopping board
- Colander
- Circle Steel Tap

54  
50  
52

- Top mount
- Flush mount
- Under mount

Cod. **SABI 45 MR**  
Cod. **SABG 45 MR**  
Cod. **SABO 45 MR**

RADIUS MARINA 45

PRO



- Colander

50

- Top mount
- Flush mount
- Under mount

Cod. **SBBI 45 MR**  
Cod. **SBBG 45 MR**  
Cod. **SBBO 45 MR**

RADIUS MARINA 45

SOLO



- Material AISI 316 L
- Finishing Brushed
- Inner corners R 10 mm welded
- Overall dimensions 490 x 440 mm
- Basin dimensions 450 x 400 mm
- Bowl depth 200 mm
- Standard Strainer 3 ½"
- Cabinet size 600 mm

- Top mount
- Flush mount
- Under mount

Cod. **BI 4540 MR**  
Cod. **BG 4540 MR**  
Cod. **BO 4540 MR**

Accessories on page 186

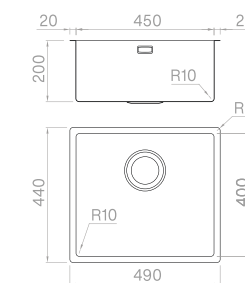

RADIUS MARINA 40

READY



- PaperStone® chopping board
- Colander
- Circle Steel Tap

54  
50  
52

- Top mount
- Flush mount
- Under mount

Cod. **SABI 40 MR**  
Cod. **SABG 40 MR**  
Cod. **SABO 40 MR**

RADIUS MARINA 40

PRO



- Colander

50

- Top mount
- Flush mount
- Under mount

Cod. **SBBI 40 MR**  
Cod. **SBBG 40 MR**  
Cod. **SBBO 40 MR**

RADIUS MARINA 40

SOLO



- Material: AISI 316 L
- Finishing: Brushed
- Inner corners: R 10 mm welded
- Overall dimensions: 440 x 440 mm
- Basin dimensions: 400 x 400 mm
- Bowl depth: 200 mm
- Standard Strainer: 3 ½"
- Cabinet size: 600 mm

- Top mount
- Flush mount
- Under mount

Cod. **BI 4040 MR**  
Cod. **BG 4040 MR**  
Cod. **BO 4040 MR**

Accessories on page 186

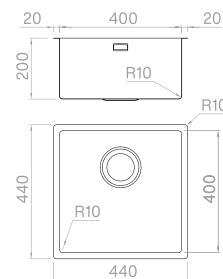

RADIUS MARINA 34

READY



- PaperStone® chopping board
- Colander
- Circle Steel Tap

54  
50  
52

- Top mount
- Flush mount
- Under mount

Cod. **SABI 34 MR**  
Cod. **SABG 34 MR**  
Cod. **SABO 34 MR**

RADIUS MARINA 34

PRO



- Colander

50

- Top mount
- Flush mount
- Under mount

Cod. **SBBI 34 MR**  
Cod. **SBBG 34 MR**  
Cod. **SBBO 34 MR**

RADIUS MARINA 34

SOLO



- Material: AISI 316 L
- Finishing: Brushed
- Inner corners: R 10 mm welded
- Overall dimensions: 380 x 440 mm
- Basin dimensions: 340 x 400 mm
- Bowl depth: 200 mm
- Standard Strainer: 3 ½"
- Cabinet size: 450 mm

- Top mount
- Flush mount
- Under mount

Cod. **BI 3440 MR**  
Cod. **BG 3440 MR**  
Cod. **BO 3440 MR**

Accessories on page 186

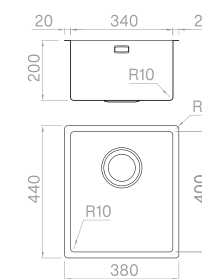



RADIUS MARINA 18

SOLO



Material	AISI 316 L
Finishing	Brushed
Inner corners	R 10 mm welded
Overall dimensions	220 x 440 mm
Basin dimensions	180 x 400 mm
Bowl depth	170 mm
Standard Strainer	3 1/2"
Cabinet size	300 mm

-  Top mount
-  Flush mount
-  Under mount

- Cod. **BI 1840 MR**
- Cod. **BG 1840 MR**
- Cod. **BO 1840 MR**

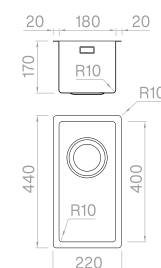

DEDICATED ACCESSORIES

PaperStone® chopping board **54**

300x420x20 mm  
Cod. **TRPS 3042**



PaperStone® chopping board **73**

200x420x19 mm  
Cod. **TRPS 2042**



PaperStone® slicer/grater set **75**

200x420x20 mm  
Cod. **TI 2442 GP**



Colander **50**

210x420x60 mm  
Cod. **VQMF 2142**

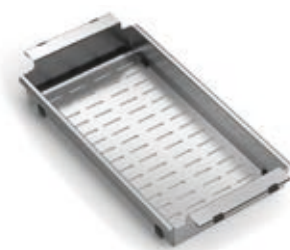

Slanted colander **51**

280x420x110/60 mm  
Cod. **VQMI 2842**



Colander **58**

210x375x60 mm  
Cod. **VQMF 2137**

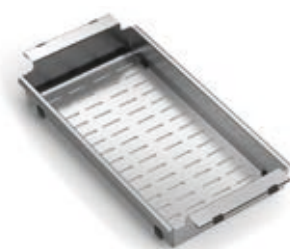



# ACCESSORY CHANNELS

# ACCESSORY CHANNELS

Developed to contain a range of interchangeable elements, the accessory channel system is perfect for space optimization and to enhance the functionality of the preparation area. Available in a variety of lengths, this modular system is offered in three different installation options for the kitchen countertop.



# INSTALLATIONS

## On Top

The accessory channel is designed with a perfect shape, rising 40 mm on the benchtop.



MODULARITY 12, 10, 8, 6, 5 AND 4 UNIT

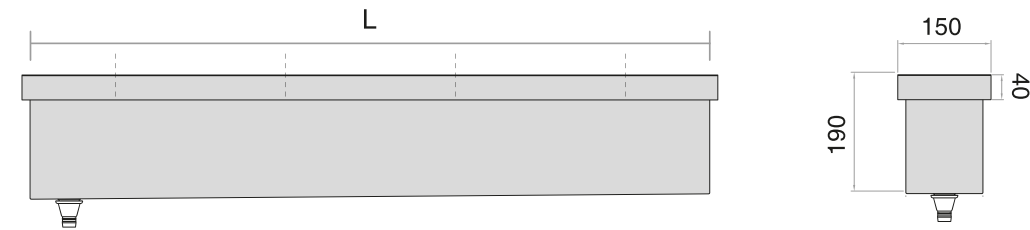

## Top mount

The top mount allows for easy installation on every type of kitchen top.

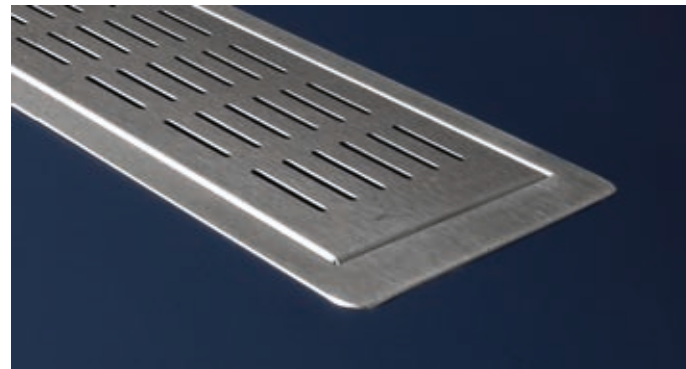

MODULARITY 12, 10, 8, 6, 5 AND 4 UNIT



## Under mount

There are no visible frames from the top, and the equipped elements are aligned with the surface.



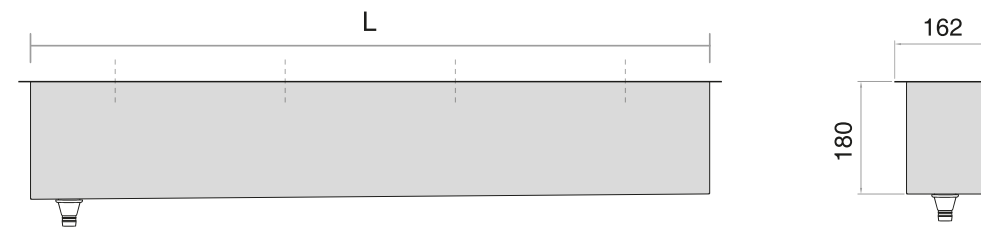

MODULARITY 12, 10, 8, 6, 5 AND 4 UNIT

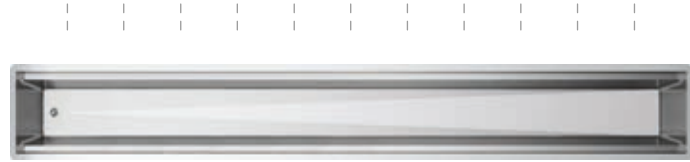

**CHANNEL 180**





Material AISI 304  
 Finishing Brushed  
 Inner dimensions 1635 x 140 mm  
 Depth 190 mm  
 Strainer Drainer kit included  
 Size 1800 mm  
 Modularity 12 units

-  On Top Cod. **CAI 18**
-  Top mount Cod. **CAG 18**
-  Under mount Cod. **CAO 180**

**CHANNEL 150**





Material AISI 304  
 Finishing Brushed  
 Inner dimensions 1363 x 140 mm  
 Depth 190 mm  
 Strainer Drainer kit included  
 Size 1500 mm  
 Modularity 10 units

-  On Top Cod. **CAI 15**
-  Top mount Cod. **CAG 15**
-  Under mount Cod. **CAO 150**

**CHANNEL 120**





Material AISI 304  
 Finishing Brushed  
 Inner dimensions 1090 x 140 mm  
 Depth 190 mm  
 Strainer Drainer kit included  
 Size 1200 mm  
 Modularity 8 units

-  On Top Cod. **CAI 12**
-  Top mount Cod. **CAG 12**
-  Under mount Cod. **CAO 120**

**CHANNEL 90**





Material AISI 304  
 Finishing Brushed  
 Inner dimensions 818 x 140 mm  
 Depth 190 mm  
 Strainer Drainer kit included  
 Size 900 mm  
 Modularity 6 units

-  On Top Cod. **CAI 90**
-  Top mount Cod. **CAG 90**
-  Under mount Cod. **CAO 90**

**CHANNEL 75**





Material AISI 304  
 Finishing Brushed  
 Inner dimensions 682 x 140 mm  
 Depth 190 mm  
 Strainer Drainer kit included  
 Size 750 mm  
 Modularity 5 units

-  On Top Cod. **CAI 75**
-  Top mount Cod. **CAG 75**
-  Under mount Cod. **CAO 75**

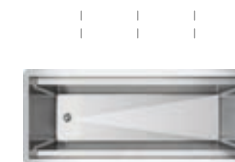
**CHANNEL 60**



Material AISI 304  
 Finishing Brushed  
 Inner dimensions 546 x 140 mm  
 Depth 190 mm  
 Strainer Drainer kit included  
 Size 600 mm  
 Modularity 4 units

-  On Top Cod. **CAI 60**
-  Top mount Cod. **CAG 60**
-  Under mount Cod. **CAO 60**

## Tool holder

136x140 mm

Cod. **PU 13 B****Unit: 1**

## Small tray

136x140 mm

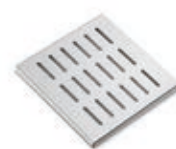
Cod. **RPF 13 B****Unit: 1**

## Small tray + device support

136x140 mm

Cod. **RFSD 13 B****Unit: 1**

## Wireless charger

136x140 mm

Cod. **CW 13 B****Unit: 1**

## Bluetooth speaker

136x140 mm

Cod. **CABL 13 B****Unit: 1**

## USB + Type C plug

136x140 mm

Cod. **PUSB 13 B****Unit: 1**

## Small tap holder

136x140 mm

Cod. **PM 13 B****Unit: 1**

## Mixer tap holder 1F

272x140 mm

Cod. **PM 1 FB****Unit: 2**

## Mixer tap holder 2F

272x140 mm

Cod. **PM 2 FB****Unit: 2**

## Mixer tap holder 3F

272x140 mm

Cod. **PM 3 FB****Unit: 2**

## Big tray

272x140 mm

Cod. **RFG 27 B****Unit: 2**

## Colander

272x140 mm

Cod. **VASF 27 B****Unit: 2**

## Colander + plate holder

272x140 mm

Cod. **VPP 27 B****Unit: 2**

## Flip socket set

272x140 mm

Cod. **PESVPB****Unit: 2**

## Garden colander

272x140 mm

Cod. **VPP 2 HB****Unit: 2**

## Garden colander

408x140 mm

Cod. **VPP 3 HB****Unit: 3**

## Colander

408x140 mm

Cod. **VASF 40 B****Unit: 3**

## Oak wood knife holder + colander

408x140 mm

Cod. **VPCLR 40 B****Unit: 3**

## Acacia wood knife holder + colander

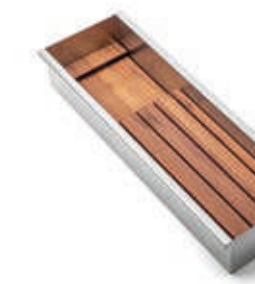

408x140 mm

Cod. **VPCL 40 B****Unit: 3**

**CHANNEL 180**

Material	AISI 304
Finishing	Brushed matte
Inner dimensions	1635 x 140 mm
Depth	190 mm
Strainer	Drainer kit included
Size	1800 mm
Modularity	12 units





-  Top mount Cod. **CAG 18 MV**
-  Under mount Cod. **CAO 180**

**CHANNEL 150**

Material	AISI 304
Finishing	Brushed matte
Inner dimensions	1363 x 140 mm
Depth	190 mm
Strainer	Drainer kit included
Size	1500 mm
Modularity	10 units





-  Top mount Cod. **CAG 15 MV**
-  Under mount Cod. **CAO 150**

**CHANNEL 120**

Material	AISI 304
Finishing	Brushed matte
Inner dimensions	1090 x 140 mm
Depth	190 mm
Strainer	Drainer kit included
Size	1200 mm
Modularity	8 units





-  Top mount Cod. **CAG 12 MV**
-  Under mount Cod. **CAO 120**

**CHANNEL 90**

Material	AISI 304
Finishing	Brushed matte
Inner dimensions	818 x 140 mm
Depth	190 mm
Strainer	Drainer kit included
Size	900 mm
Modularity	6 units





-  Top mount Cod. **CAG 90 MV**
-  Under mount Cod. **CAO 90**

**CHANNEL 75**

Material	AISI 304
Finishing	Brushed matte
Inner dimensions	682 x 140 mm
Depth	190 mm
Strainer	Drainer kit included
Size	750 mm
Modularity	5 units





-  Top mount Cod. **CAG 75 MV**
-  Under mount Cod. **CAO 75**

**CHANNEL 60**

Material	AISI 304
Finishing	Brushed matte
Inner dimensions	546 x 140 mm
Depth	190 mm
Strainer	Drainer kit included
Size	600 mm
Modularity	4 units



-  Top mount Cod. **CAG 60 MV**
-  Under mount Cod. **CAO 60**

**Tool holder**

136x140 mm

**Unit: 1**

Cod. **PU 13 MV**



**Small tray**

136x140 mm

**Unit: 1**

Cod. **RPF 13 MV**

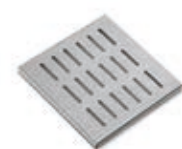

**Small tray + device support**

136x140 mm

**Unit: 1**

Cod. **RFS 13 MV**

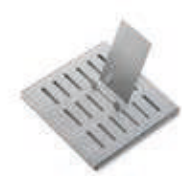

**Colander + plate holder**

272x140 mm

**Unit: 2**

Cod. **VPP 27 MV**



**Flip socket set**

272x140 mm

**Unit: 2**

Cod. **PESVP MV**



**Garden colander**

272x140 mm

**Unit: 2**

Cod. **VPP 2H MV**



**Wireless charger**

136x140 mm

**Unit: 1**

Cod. **CW 13 MV**

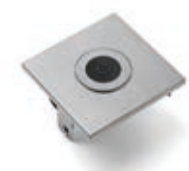

**Bluetooth speaker**

136x140 mm

**Unit: 1**

Cod. **CABL 13 MV**

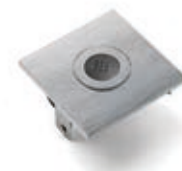

**USB + Type C plug**

136x140 mm

**Unit: 1**

Cod. **PUSB 13 MV**



**Garden colander**

408x140 mm

**Unit: 3**

Cod. **VPP 3H MV**



**Colander**

408x140 mm

**Unit: 3**

Cod. **VASF 40 MV**



**Oak wood knife holder + colander**

408x140 mm

**Unit: 3**

Cod. **VPCLR 40 M**



**Small tap holder**

136x140 mm

**Unit: 1**

Cod. **PM 13 MV**



**Mixer tap holder 1F**

272x140 mm

**Unit: 2**

Cod. **PM 1F MV**



**Mixer tap holder 2F**

272x140 mm

**Unit: 2**

Cod. **PM 2F MV**



**Mixer tap holder 3F**

272x140 mm

**Unit: 2**

Cod. **PM 3F MV**



**Big tray**

272x140 mm

**Unit: 2**

Cod. **RFG 27 MV**



**Colander**

272x140 mm

**Unit: 2**

Cod. **VASF 27 MV**



**Acacia wood knife holder + colander**

408x140 mm

**Unit: 3**

Cod. **VPCL 40 MV**

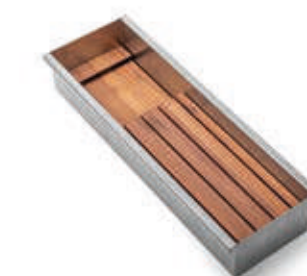



# SINK MIXERS



## ATHOM GUN METAL

42

Finishing	PVD gun metal
Swivel angle	180°
Installation hole	Ø 35 mm
Cartridge	ceramic disc
Spray	extractable

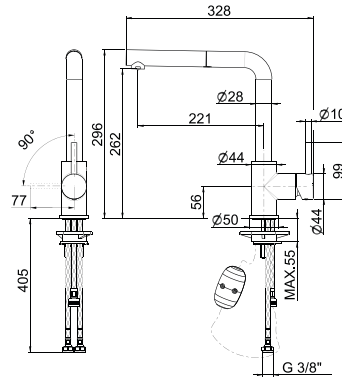
Cod. **SS 02721**

## ATHOM COPPER BRONZE

43

Finishing	PVD copper bronze
Swivel angle	180°
Installation hole	Ø 35 mm
Cartridge	ceramic disc
Spray	extractable

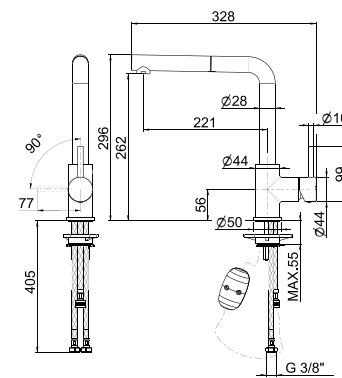
Cod. **SS 02722**

## ATHOM PALE GOLD

44

Finishing	PVD pale gold
Swivel angle	180°
Installation hole	Ø 35 mm
Cartridge	ceramic disc
Spray	extractable

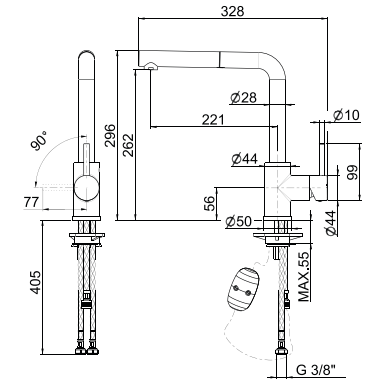
Cod. **SS 02723**

## CIRCLE

45

Finishing	Inox Brushed
Swivel angle	360°
Installation hole	Ø 35 mm
Cartridge	ceramic disc
Spray	extractable

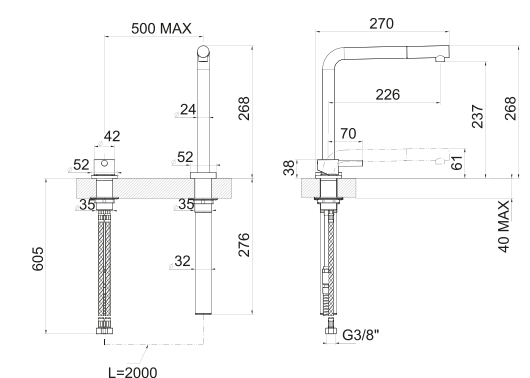
Cod. **SS 02700**

## UBER



46

Material	Stainless steel AISI 304
Finishing	Brushed
Swivel angle	360°
Installation hole	Ø 35 mm
Cartridge	ceramic disc

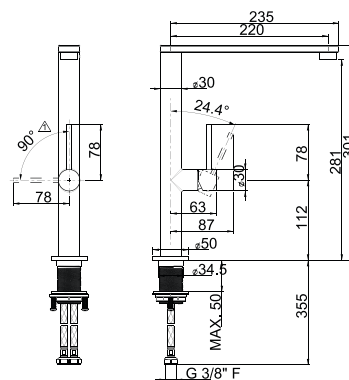
Cod. **SS 02720**

## VERTIGO



47

Finishing	Inox Brushed
Swivel angle	360°
Installation hole	Ø 35 mm
Cartridge	ceramic disc

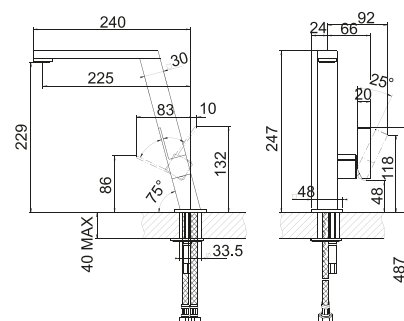
Cod. **SS 01164**

## CIRCLE STEEL



52

Material	Stainless steel AISI 316 L
Finishing	Brushed
Swivel angle	360°
Installation hole	Ø 35 mm
Cartridge	ceramic disc
Spray	extractable

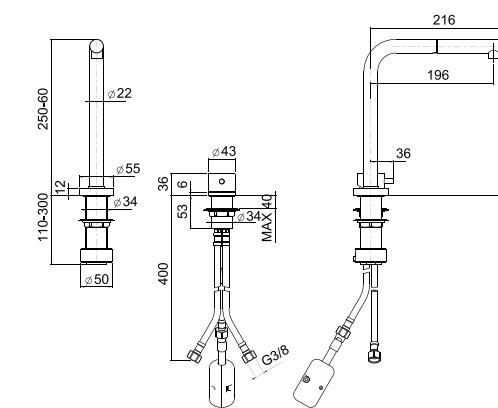
Cod. **SS 02802**

## ARIAL STEEL



59

Material	Stainless steel AISI 316 L
Finishing	Brushed
Swivel angle	360°
Installation hole	Ø 35 mm
Cartridge	ceramic disc
Spray	extractable

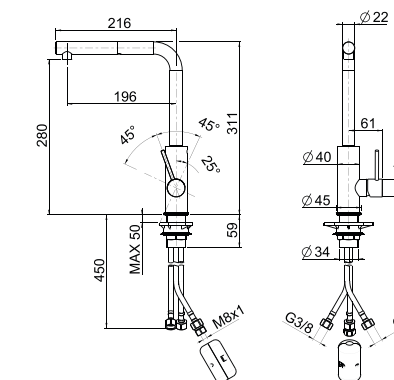
Cod. **SS 02820**

# COMPLEMENTS

## STRAINERS AND OVERFLOWS



**PLUS –  
BRUSHED**  
Cod. **SS 02608**



**STANDARD –  
BRUSHED**  
Cod. **SS 02740**



**BLACK –  
MATTE BLACK**  
Cod. **SS 02741**



**ECLISSE –  
BRUSHED**  
It allows the outflow.  
3 ½" strainer compatible.  
  
Cod. **SS 02748**

## STRAINERS AND OVERFLOWS – TITANIUM



**PLUS –  
GUN METAL**  
Cod. **SS 02717**

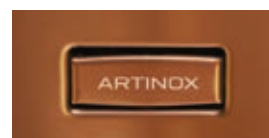

**PLUS –  
COPPER BRONZE**  
Cod. **SS 02716**

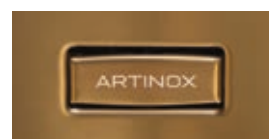

**PLUS –  
PALE GOLD**  
Cod. **SS 02715**

## AUTOMATIC DRAIN SYSTEMS



**POP-UP – PLUS**  
Pressure actuation.

Cod. **SS 02744**



**POP-UP – STANDARD**  
Pressure actuation.

Cod. **SS 02742**



**POP-UP – BLACK**  
Pressure actuation.

Cod. **SS 02743**



## AUTOMATIC DRAIN SYSTEMS – TITANIUM



**POP-UP – PLUS**  
**Gun Metal** – Pressure actuation.

Cod. **SS 02747**



**POP-UP – PLUS**  
**Copper Bronze** – Pressure actuation.

Cod. **SS 02746**



**POP-UP – PLUS**  
**Pale Gold** – Pressure actuation.

Cod. **SS 02745**



## 'U' TRAPS



Space-saving self-cleaning 'U' trap drainage outlet for single or double drain sinks; dishwasher attachment included.

Cod. **1 way** **SS 00448**

Cod. **2 ways** **SS 00449**

## FOOD WASTE DISPOSER



Brushed steel – It allows the outflow.

3 ½" strainer compatible.

Titanium and Matte Vintage not available.

Cod. **TRFWD 60T**

## STAINLESS STEEL CARE



### CLEANING - COMPLETE KIT

- Cleansing cream (250 ml bottle)
- Cleaning cloth
- Finishing cloth

Cod. **SS 01751**

Cod. **SS 02771** [12 Pks.]



### CLEANSING CREAM

Specific for stainless steel.

Cod. **SS 02772** [12 Pcs.]



### ANTIBACTERIAL CLOTH

Microfiber for finishing.

Size 40x40 cm – pack of 3 pieces.

Cod. **SS 02774** [12 Pks.]

ARTINOX workstation sinks are made of AISI 304 18/10 (EN 1.4301) stainless steel, a chromium-nickel steel alloy. Stainless steel is the hygienic material par excellence, tough and very resistant to corrosion, the ideal product for contact with food. All ARTINOX items are made in compliance with the strictest quality standards and tested one by one.

### WARNINGS

Like all materials, stainless steel also requires regular care and daily cleaning. Improper use can damage the surface even permanently. The following recommendations protect the sink from corrosion damage caused by unsuitable cleaning agents.

### CLEANING

For daily cleaning, we recommend squeezing a sponge out of hot water and dipping it in white vinegar. For deep cleaning, use ONLY official Artinox products, which can be purchased from authorized dealers or by consulting [www.artinox.com](http://www.artinox.com).

### MAINTENANCE

After each use, clean, rinse and dry the sink thoroughly with a soft cloth.

DO NOT leave detergents and cleaning products in contact with the surface for a long time.

DO NOT use hydrochloric acid, hydrofluoric acid, phosphoric acid, bleach, ammonia, or detergents that contain even small doses of these substances. DO NOT use abrasive sponges, detergents and creams.

DO NOT leave objects, ferrous and non-ferrous metals inside the sink

---

## GENERAL SELLING CONDITIONS

---

### **How to order:**

We accept only written and complete orders. The order must indicate codes, as written in this price-list. Confirmation of order will follow, by fax and/or mail, and it is considered accepted if not contested within 3 days. The company Artinox spa reserves the right to change and/or cancel, if necessary, products, dimensions, descriptions and prices shown in this price list without notice and without any possibility for the customer to claim.

### **Delivery:**

The delivery times are approximate and in reference to normal working conditions. In no case shall the seller be asked for reimbursement for any damages due to delayed delivery, nor shall the delay constitute a reason for cancellation of the contract. Quality and type of goods must be checked by the buyer at delivery.

### **Delivery terms:**

Exw Conegliano (Treviso) Italy. Goods travel at the consignee's risk, even in case of free of charge delivery.

### **Packing:**

Standard packing in cardboard boxes included in price. Special packing shall be charged at cost.

### **Prices:**

The prices shown in this price list are exclusive of: vat, carriage, special packing, customs duties, wooden crates and/or pallets, assembly and final test and inspection.

### **Terms of payment:**

To be agreed. All charges related to payment of bank commissions, stamp duties, etc. Shall be debited on the invoice. In the event of delayed payments, the company reserves the right to suspend delivery of the orders on hand, without obligation to give notice. The parties agree that the buyer will get the ownership of the material after payment of the total price, Accessories included, but he will take the risks after delivery of the goods [ex art. 1523 c.c. Italian law]. After the payment terms agreed by the two parties have fallen due, no complaint relating the quality of the goods can be made, unless regular payment of the goods has been effected.

### **Default interest:**

Any delay in payments automatically leads to the charging of default interest at a rate of 1,5 % a month from the expiry date which is indicated in the invoice. Any charges borne to recover due amounts are for the buyer's account.

---

### **Warranty:**

The warranty period is 24 months from the date of dispatch and covers every single part. The seller is not responsible for direct and/or indirect damages caused by and/or to equipments, plants, people for improper use, for bumps, wrong installation, for use out of tolerance.

Please give immediately notice of surface flaws such as blows, scratches, stains or breakages before installing or using any product. Any defect pointed out after the installation, as not attributable to fabrication flaws, will be excluded from the warranty.

Faulty parts are to be delivered ex our works (Conegliano Treviso - Italy) and will be replaced under guarantee only after through check. The recognized faulty parts will be replaced and mailed or sent free of charge by carrier. The guarantee does not cover the charges of replacement of parts, it is not transferable and complete replacement of parts or appliance is at the final discretion of the manufacturer.

Each product in this catalog is manufactured in compliance to current regulations and CE directives.

All data shown are not binding.

Artinox S.p.a. reserves the right to make changes deemed useful for the improvement of its offer at any time, without notice and disclaiming any responsibility for errors or inaccuracies.

The reproduction of the colors in the catalog are to be considered indicative.

Reproductions of all or part of this catalog are prohibited without the specific written authorization of Artinox S.p.a.

© Copyright 2024 Artinox S.p.a. - All rights reserved.

**Ed. 2 - June 2024**

CONCEPT

**Artinox S.p.A.**

GRAPHIC DESIGN

**Marta Amistani – Topvisualbeauty.com**

PHOTOGRAPHY

**Michele Salucci – Immaginarìa Srl**

PRINT

**Grafiche Antiga**

