

TITANIUM

ARTINOX

TITANIUM GUN METAL



TITANIUM 70 GUN METAL**READY**

Vaschetta forata Gun Metal
Miscelatore Athom

17

42

Cod. **SAT I 70 RA**Cod. **SATG 70 RA**Cod. **SATO 70 RA****TITANIUM 70 GUN METAL****PRO**

Vaschetta forata Gun Metal

17

Cod. **SBT I 70 RA**Cod. **SBTG 70 RA**Cod. **SBTO 70 RA****TITANIUM 70 GUN METAL****SOLO**

Materiale	AISI 304
Finitura	PVD Gun Metal
Raggio interno	Saldato 10 mm
Misure esterne	740 x 440 mm
Misure vasca	700 x 400 mm
Profondità vasca	200 mm
Piletta Plus Gun Metal	Ø 3 1/2"
Base	800 mm

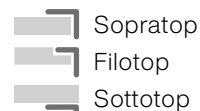
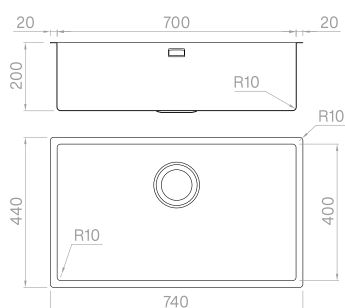
Cod. **TI 7040 RA**Cod. **TG 7040 RA**Cod. **TO 7040 RA****Accessori**

Vedi pag. 15 per tutti gli accessori dedicati.

TITANIUM 50 GUN METAL

READY



Vaschetta forata Gun Metal
Miscelatore Athom

17
42

- Sopratop
- Filotop
- Sottotop

Cod. **SAT I 50 RA**
Cod. **SATG 50 RA**
Cod. **SATO 50 RA**

TITANIUM 50 GUN METAL

PRO



Vaschetta forata Gun Metal

17

- Sopratop
- Filotop
- Sottotop

Cod. **SBT I 50 RA**
Cod. **SBTG 50 RA**
Cod. **SBTO 50 RA**

TITANIUM 50 GUN METAL

SOLO



Materiale	AISI 304
Finitura	PVD Gun Metal
Raggio interno	Saldato 10 mm
Misure esterne	540 x 440 mm
Misure vasca	500 x 400 mm
Profondità vasca	200 mm
Piletta Plus Gun Metal	Ø 3 1/2"
Base	600 mm

- Sopratop
- Filotop
- Sottotop

Cod. **TI 5040 RA**
Cod. **TG 5040 RA**
Cod. **TO 5040 RA**

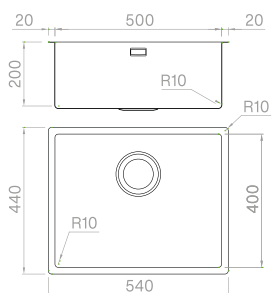

Accessori



Vedi pag. 15 per tutti gli accessori dedicati.

TITANIUM 40 GUN METAL

READY



Vaschetta forata Gun Metal
Miscelatore Athom

17
42



Cod. **SAT I 40 RA**
Cod. **SATG 40 RA**
Cod. **SATO 40 RA**

TITANIUM 40 GUN METAL

PRO



Vaschetta forata Gun Metal

17



Cod. **SBT I 40 RA**
Cod. **SBTG 40 RA**
Cod. **SBTO 40 RA**

TITANIUM 40 GUN METAL

SOLO



Materiale	AISI 304
Finitura	PVD Gun Metal
Raggio interno	Saldato 10 mm
Misure esterne	440 x 440 mm
Misure vasca	400 x 400 mm
Profondità vasca	200 mm
Piletta Plus Gun Metal	Ø 3 1/2"
Base	600 mm

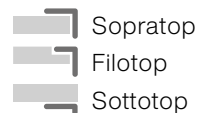

Cod. **TI 4040 RA**
Cod. **TG 4040 RA**
Cod. **TO 4040 RA**

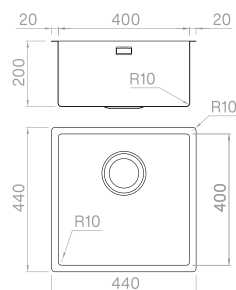

Accessori



Vedi pag. 15 per tutti gli accessori dedicati.

TITANIUM COPPER BRONZE

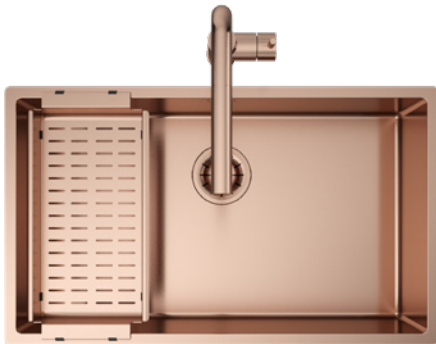

TITANIUM 70 COPPER BRONZE**READY**

Vaschetta forata Copper Bronze
 Miscelatore Athom

18**43**Cod. **SAT I 70 RC**Cod. **SATG 70 RC**Cod. **SATO 70 RC****TITANIUM 70 COPPER BRONZE****PRO**

Vaschetta forata Copper Bronze

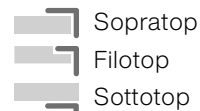
18Cod. **SBT I 70 RC**Cod. **SBTG 70 RC**Cod. **SBTO 70 RC****TITANIUM 70 COPPER BRONZE****SOLO**

Materiale	AISI 304
Finitura	PVD Copper Bronze
Raggio interno	Saldato 10 mm
Misure esterne	740 x 440 mm
Misure vasca	700 x 400 mm
Profondità vasca	200 mm
Piletta Plus Copper Bronze	Ø 3 1/2"
Base	800 mm

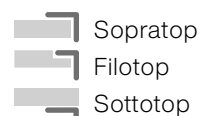
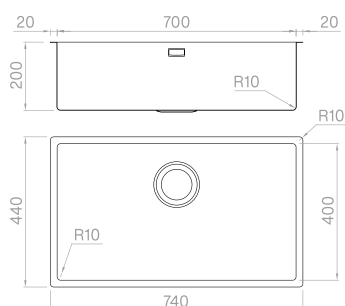
Cod. **TI 7040 RC**Cod. **TG 7040 RC**Cod. **TO 7040 RC****Accessori**

Vedi pag. 15 per tutti gli accessori dedicati.

TITANIUM 50 COPPER BRONZE

READY

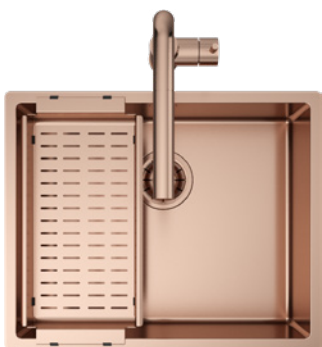

Vaschetta forata Copper Bronze
Miscelatore Athom

18
43

- Sopratop
- Filotop
- Sottotop

Cod. **SAT I 50 RC**
Cod. **SATG 50 RC**
Cod. **SATO 50 RC**

TITANIUM 50 COPPER BRONZE

PRO



Vaschetta forata Copper Bronze

18

- Sopratop
- Filotop
- Sottotop

Cod. **SBT I 50 RC**
Cod. **SBTG 50 RC**
Cod. **SBTO 50 RC**

TITANIUM 50 COPPER BRONZE

SOLO



Materiale	AISI 304
Finitura	PVD Copper Bronze
Raggio interno	Saldato 10 mm
Misure esterne	540 x 440 mm
Misure vasca	500 x 400 mm
Profondità vasca	200 mm
Piletta Plus Copper Bronze	Ø 3 1/2"
Base	600 mm

- Sopratop
- Filotop
- Sottotop

Cod. **TI 5040 RC**
Cod. **TG 5040 RC**
Cod. **TO 5040 RC**

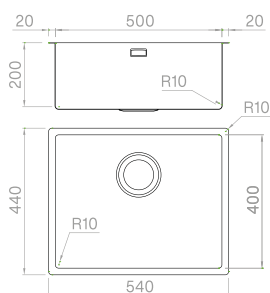

Accessori



Vedi pag. 15 per tutti gli accessori dedicati.

TITANIUM 40 COPPER BRONZE**READY**

Vaschetta forata Copper Bronze
 Miscelatore Athom

18

43

-  Sopratop
-  Filotop
-  Sottotop

Cod. **SAT I 40 RC**Cod. **SATG 40 RC**Cod. **SATO 40 RC****TITANIUM 40 COPPER BRONZE****PRO**



Vaschetta forata Copper Bronze

18

-  Sopratop
-  Filotop
-  Sottotop

Cod. **SBT I 40 RC**Cod. **SBTG 40 RC**Cod. **SBTO 40 RC****TITANIUM 40 COPPER BRONZE****SOLO**

Materiale	AISI 304
Finitura	PVD Copper Bronze
Raggio interno	Saldato 10 mm
Misure esterne	440 x 440 mm
Misure vasca	400 x 400 mm
Profondità vasca	200 mm
Piletta Plus Copper Bronze	Ø 3 1/2"
Base	600 mm

-  Sopratop
-  Filotop
-  Sottotop

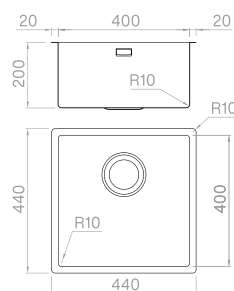
Cod. **TI 4040 RC**Cod. **TG 4040 RC**Cod. **TO 4040 RC****Accessori**

Vedi pag. 15 per tutti gli accessori dedicati.

TITANIUM PALE GOLD



TITANIUM 70 PALE GOLD**READY**

Vaschetta forata Pale Gold
Miscelatore Athom

19

44

Cod. **SAT I 70 RG**Cod. **SATG 70 RG**Cod. **SATO 70 RG****TITANIUM 70 PALE GOLD****PRO**

Vaschetta forata Pale Gold

19

Cod. **SBT I 70 RG**Cod. **SBTG 70 RG**Cod. **SBTO 70 RG****TITANIUM 70 PALE GOLD****SOLO**

Materiale	AISI 304
Finitura	PVD Pale Gold
Raggio interno	Saldato 10 mm
Misure esterne	740 x 440 mm
Misure vasca	700 x 400 mm
Profondità vasca	200 mm
Piletta Plus Pale Gold	Ø 3 1/2"
Base	800 mm

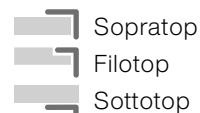
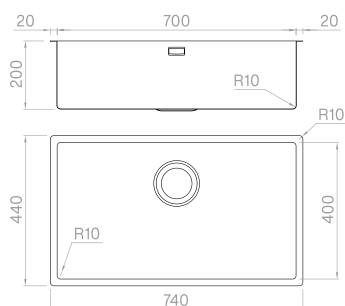
Cod. **TI 7040 RG**Cod. **TG 7040 RG**Cod. **TO 7040 RG****Accessori**

Vedi pag. 15 per tutti gli accessori dedicati.

TITANIUM 50 PALE GOLD**READY**

Vaschetta forata Pale Gold
Miscelatore Athom

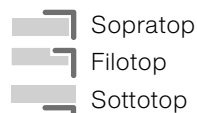
19**44**Cod. **SAT I 50 RG**Cod. **SATG 50 RG**Cod. **SATO 50 RG****TITANIUM 50 PALE GOLD****PRO**

Vaschetta forata Pale Gold

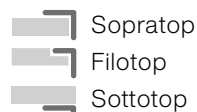
19Cod. **SBT I 50 RG**Cod. **SBTG 50 RG**Cod. **SBTO 50 RG****TITANIUM 50 PALE GOLD****SOLO**

Materiale	AISI 304
Finitura	PVD Pale Gold
Raggio interno	Saldato 10 mm
Misure esterne	540 x 440 mm
Misure vasca	500 x 400 mm
Profondità vasca	200 mm
Piletta Plus Pale Gold	Ø 3 1/2"
Base	600 mm

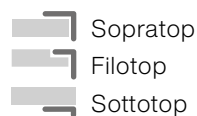
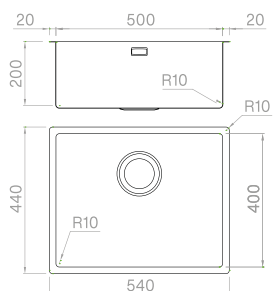
Cod. **TI 5040 RG**Cod. **TG 5040 RG**Cod. **TO 5040 RG****Accessori**

Vedi pag. 15 per tutti gli accessori dedicati.

TITANIUM 40 PALE GOLD**READY**

Vaschetta forata Pale Gold
Miscelatore Athom

19

44

Cod. **SAT I 40 RG**Cod. **SATG 40 RG**Cod. **SATO 40 RG****TITANIUM 40 PALE GOLD****PRO**

Vaschetta forata Pale Gold

19

Cod. **SBT I 40 RG**Cod. **SBTG 40 RG**Cod. **SBTO 40 RG****TITANIUM 40 PALE GOLD****SOLO**

Materiale	AISI 304
Finitura	PVD Pale Gold
Raggio interno	Saldato 10 mm
Misure esterne	440 x 440 mm
Misure vasca	400 x 400 mm
Profondità vasca	200 mm
Piletta Plus Pale Gold	Ø 3 1/2"
Base	600 mm

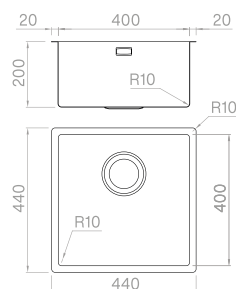
Cod. **TI 4040 RG**Cod. **TG 4040 RG**Cod. **TO 4040 RG****Accessori**

Vedi pag. 15 per tutti gli accessori dedicati.



Tagliere in legno**3**

300x420x20 mm
Cod. **TRIB 3042**

**Tagliere in HDPE****6**

240x420x20 mm
Cod. **TRP 2442**

**Vaschetta forata Gun Metal****17**

210x420x60 mm
Cod. **VQAF 2142**

**Vaschetta forata Copper Bronze****18**

210x420x60 mm
Cod. **VQCF 2142**

**Vaschetta forata Pale Gold****19**

210x420x60 mm
Cod. **VQGF 2142**

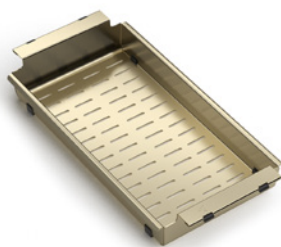
**Set gastronorm****30**

240x420x100 mm
Cod. **TI 2442 V**

**Set scolapasta****32**

240x420x100 mm
Cod. **TI 2442 1S**

**Set grattugie****34**

240x420x28 mm
Cod. **TI 2442 PG**



Disclaimer

Ogni articolo in questo catalogo è prodotto in conformità alle normative vigenti e alle direttive CE.

Tutti i dati riportati non sono vincolanti.

Artinox S.p.a. si riserva la facoltà di apportare modifiche ritenute utili al miglioramento della propria offerta in qualsiasi momento, senza preavviso e declinando ogni responsabilità per eventuali errori o inesattezze.

La riproduzione delle colorazioni a catalogo sono da ritenersi indicative.

Sono vietate le riproduzioni nel suo insieme o in parte del presente catalogo, senza la specifica autorizzazione scritta di Artinox S.p.a.

© Copyright 2023 Artinox S.p.a. - Tutti i diritti riservati.

Artinox SpA

Via F. Fabbrì, 39 z.i. Campidui

31015 Conegliano (TV)

Italy

Tel. +39 0438 4531

Mail

Artinox S.p.a. è certificata UNI EN ISO 9001 e UNI EN ISO 14001



