

PLANUM

ARTINOX

PLANUM XL



PLANUM XL 111

READY

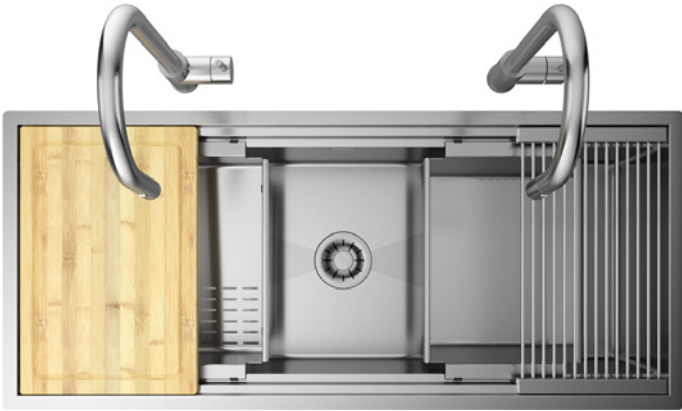

- Wooden chopping board
- Slanted colander
- Basin
- Grid
- Loft Tap
- Loft Tap

- 1
- 23
- 26
- 10
- 38
- 38

 Top mount

Cod. **SAP I 11**

PLANUM XL 111

PRO

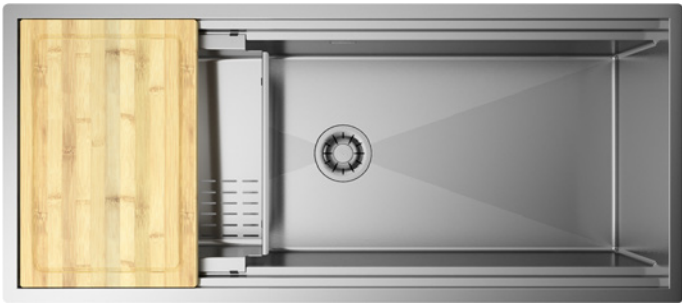

- Wooden chopping board
- Slanted colander

- 1
- 23

 Top mount

Cod. **SBP I 11**

PLANUM XL 111

SOLO

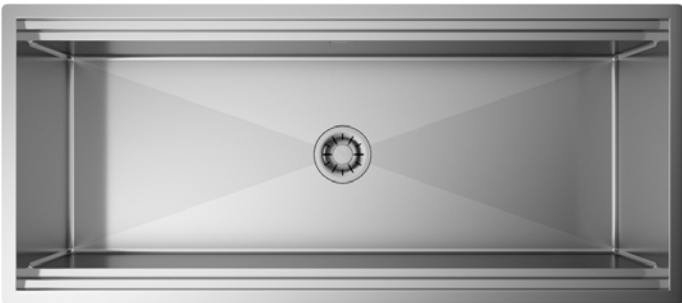

Material	AISI 304
Finishing	Brushed
Corner radius	Welded 10 mm
Overall dimensions	1160 x 510 mm
Basin dimensions	1110 x 400 mm
Bowl depth	254 mm
Plus Strainer	Ø 3 1/2"
Cabinet	1200 mm

 Top mount

Cod. **PI 11 4025**

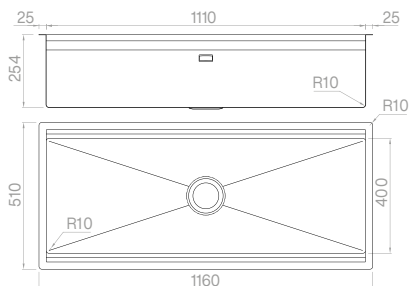

Accessories



See p. 7 for all dedicated accessories.

PLANUM XL 81

READY

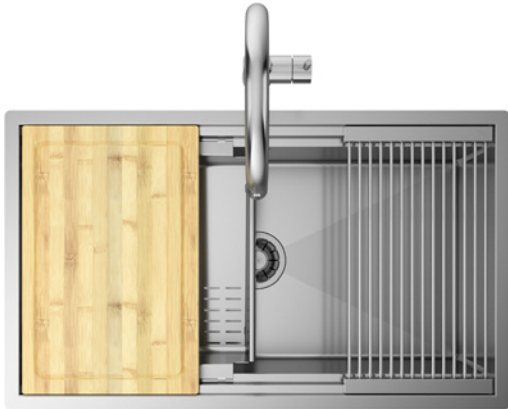

- Wooden chopping board
- Slanted colander
- Grid
- Loft Tap

- 1
- 23
- 10
- 38

 Top mount

Cod. **SAP I 81**

PLANUM XL 81

PRO

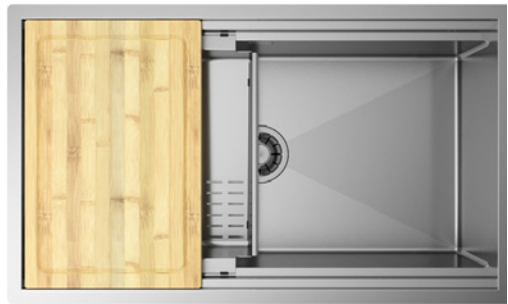

- Wooden chopping board
- Slanted colander

- 1
- 23

 Top mount

Cod. **SBP I 81**

PLANUM XL 81

SOLO



- | | |
|--------------------|--------------|
| Material | AISI 304 |
| Finishing | Brushed |
| Corner radius | Welded 10 mm |
| Overall dimensions | 860 x 510 mm |
| Basin dimensions | 810 x 400 mm |
| Bowl depth | 254 mm |
| Plus Strainer | Ø 3 1/2" |
| Cabinet | 900 mm |

 Top mount

Cod. **PI 81 4025**

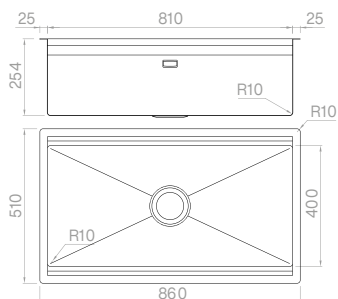

Accessories



See p. 7 for all dedicated accessories.

PLANUM XL 70

READY

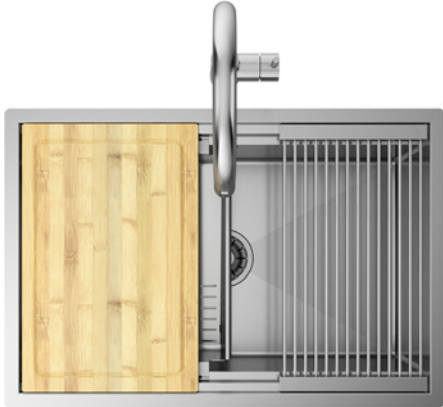

- Wooden chopping board
- Slanted colander
- Grid
- Loft Tap

- 1
- 23
- 10
- 38



Cod. **SAP I 70**

PLANUM XL 70

PRO



- Wooden chopping board
- Slanted colander

- 1
- 23



Cod. **SBP I 70**

PLANUM XL 70

SOLO



- | | |
|--------------------|--------------|
| Material | AISI 304 |
| Finishing | Brushed |
| Corner radius | Welded 10 mm |
| Overall dimensions | 750 x 510 mm |
| Basin dimensions | 700 x 400 mm |
| Bowl depth | 254 mm |
| Plus Strainer | Ø 3 1/2" |
| Cabinet | 800 mm |



Cod. **PI 70 4025**

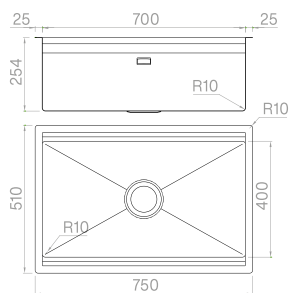

Accessories



See p. 7 for all dedicated accessories.

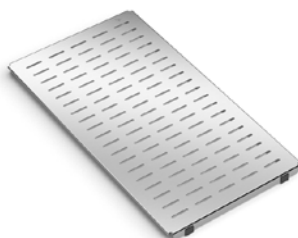

Wooden chopping board**1**300x460x20 mm
Cod. **TRIB 3045****HDPE chopping board****6**427x240x20 mm
Cod. **TRP 2442****Bottle holder set****7**130x457x170 mm
Cod. **VPB 3C****Drainer****8**250x450x15 mm
Cod. **VPB 2545****Grid****10**300x450x25 mm
Cod. **GRS 3045****Colander****16**210x420x60 mm
Cod. **VQSF 2142****Slanted colander****23**280x420x110/60 mm
Cod. **VQSI 2842****Basin****26**280x420x160 mm
Cod. **VQSP 2842****Gastronorm set****30**240x420x100 mm
Cod. **TI 2442 V****Strainer set****32**240x420x100 mm
Cod. **TI 2442 1S****Slicer/grater set****34**240x420x28 mm
Cod. **TI 2442 PG****Dish holder****36**250x420x55 mm
Cod. **PPPB V400**

PLANUM BR



PLANUM BR 111

READY



- Wooden chopping board 2
- Slanted colander 25
- Basin 27
- Grid 11
- Loft Tap 38

Top mount

Cod. **SAP BRI 11**

PLANUM BR 111

PRO

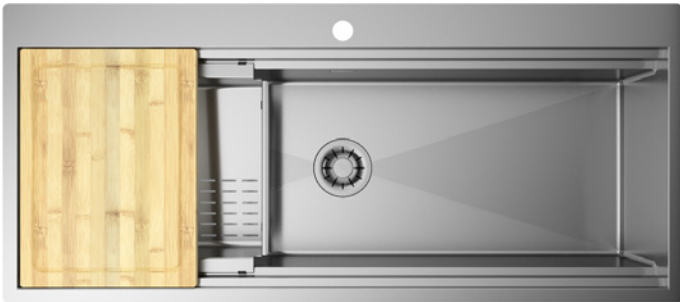

- Wooden chopping board 2
- Slanted colander 25

Top mount

Cod. **SBP BRI 11**

PLANUM BR 111

SOLO

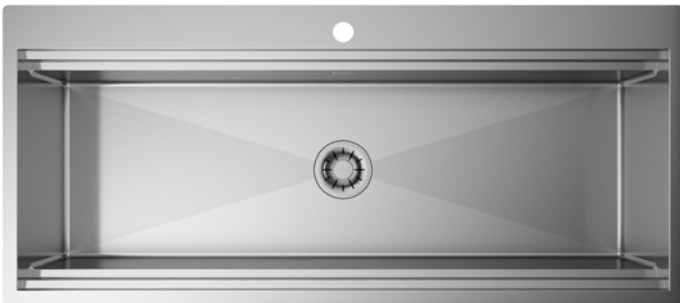

Material	AISI 304
Finishing	Brushed
Corner radius	Welded 10 mm
Overall dimensions	1160 x 510 mm
Basin dimensions	1110 x 350 mm
Bowl depth	224 mm
Plus Strainer	Ø 3 1/2"
Cabinet	1200 mm

Top mount

Cod. **ALP BRI 11**

Mixer hole:
specify extra
holes when
ordering.

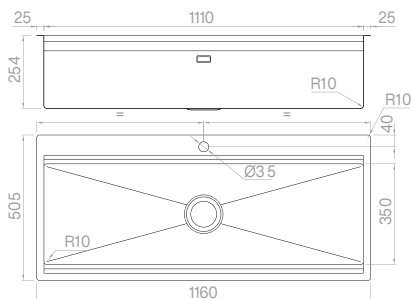

Accessories



See p. 17 for all dedicated accessories.

PLANUM BR 81

READY

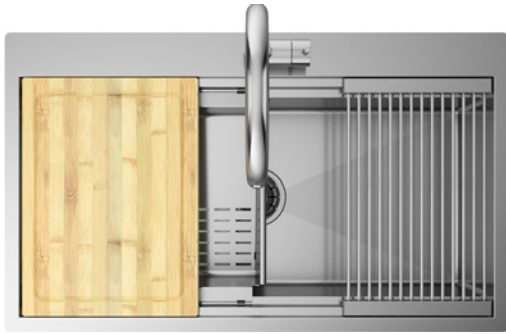

- Wooden chopping board
- Slanted colander
- Grid
- Loft Tap

- 2
- 25
- 11
- 38

 Top mount

Cod. **SAP BRI 81**

PLANUM BR 81

PRO

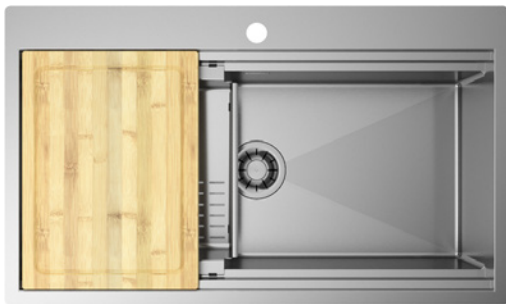

- Wooden chopping board
- Slanted colander

- 2
- 25

 Top mount

Cod. **SBP BRI 81**

PLANUM BR 81

SOLO

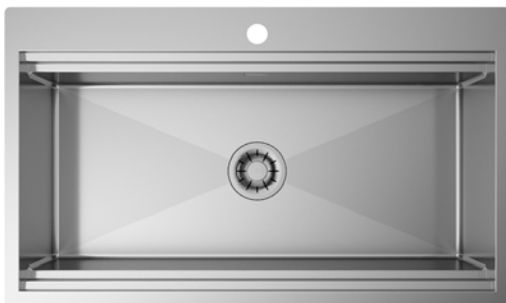

Material	AISI 304
Finishing	Brushed
Corner radius	Welded 10 mm
Overall dimensions	860 x 510 mm
Basin dimensions	810 x 350 mm
Bowl depth	224 mm
Plus Strainer	Ø 3 1/2"
Cabinet	900 mm

 Top mount

Cod. **ALP BRI 81**

Mixer hole: specify extra holes when ordering.

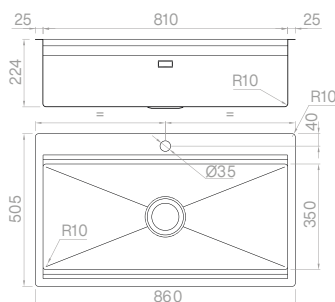

Accessories



See p. 17 for all dedicated accessories.

PLANUM BR 70

READY

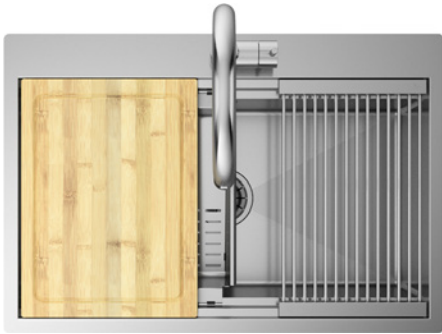

- Wooden chopping board
- Slanted colander
- Grid
- Loft Tap

- 2
- 25
- 11
- 38



Cod. **SAP BRI 70**

PLANUM BR 70

PRO

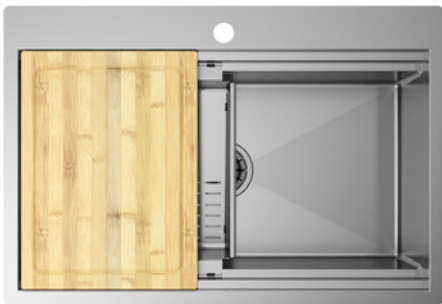

- Wooden chopping board
- Slanted colander

- 2
- 25



Cod. **SBP BRI 70**

PLANUM BR 70

SOLO



Material	AISI 304
Finishing	Brushed
Corner radius	Welded 10 mm
Overall dimensions	750 x 510 mm
Basin dimensions	700 x 350 mm
Bowl depth	224 mm
Plus Strainer	Ø 3 1/2"
Cabinet	800 mm



Cod. **ALP BRI 70**

Mixer hole: specify extra holes when ordering.

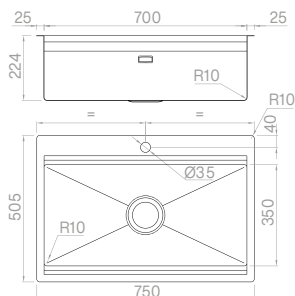

Accessories



See p. 17 for all dedicated accessories.

PLANUM ST

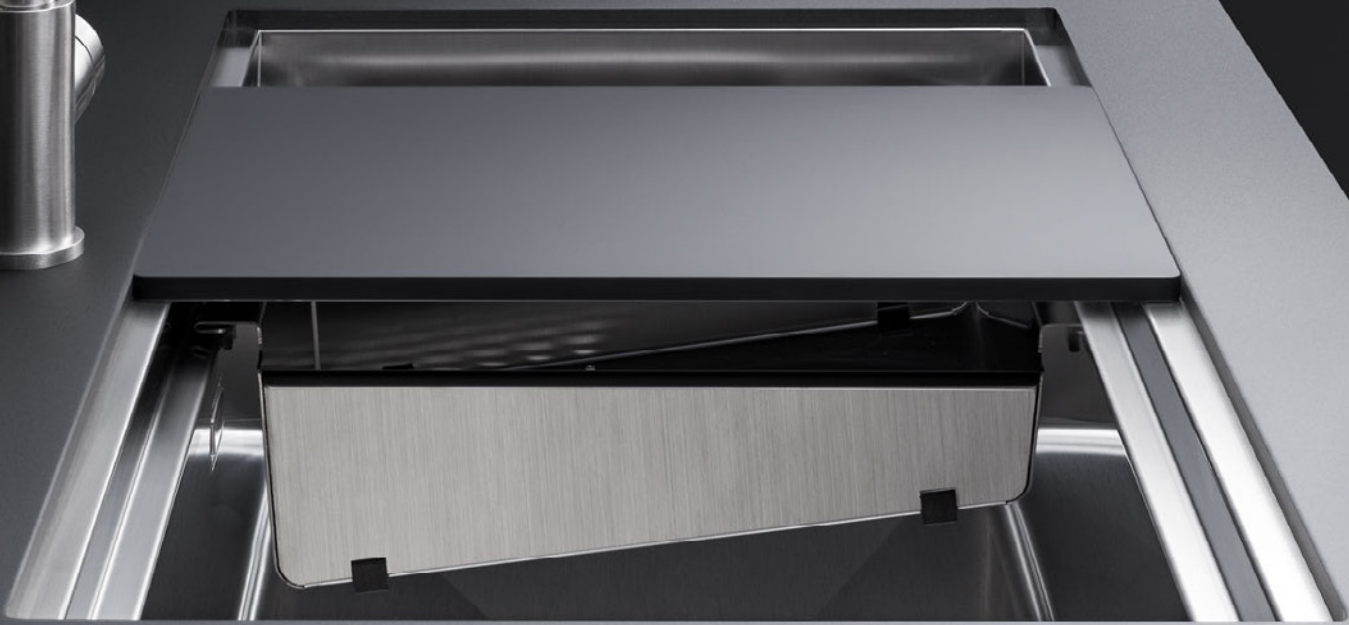

PLANUM ST 111

READY



- Wooden chopping board
- Slanted colander
- Basin
- Grid
- Loft Tap

- 2
- 25
- 27
- 11
- 38

 Under mount

Cod. **SAPO 11 L1**

PLANUM ST 111

PRO

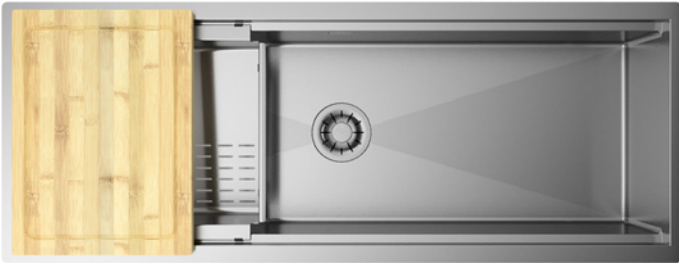

- Wooden chopping board
- Slanted colander

- 2
- 25

 Under mount

Cod. **SBPO 11 L1**

PLANUM ST 111

SOLO



Material	AISI 304
Finishing	Brushed
Corner radius	Welded 10 mm
Overall dimensions	1160 x 510 mm
Basin dimensions	1110 x 350 mm
Bowl depth	224 mm
Plus Strainer	Ø 3 1/2"
Cabinet	1200 mm

 Under mount

Cod. **PO 11 L1**

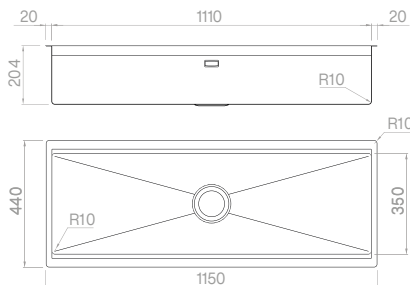

Accessories



See p. 17 for all dedicated accessories.

PLANUM ST 81

READY

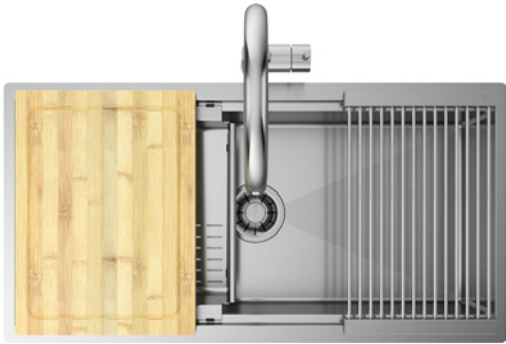

- Wooden chopping board
- Slanted colander
- Grid
- Loft Tap

- 2
- 25
- 11
- 38

 Under mount

Cod. **SAPO 81 L1**

PLANUM ST 81

PRO

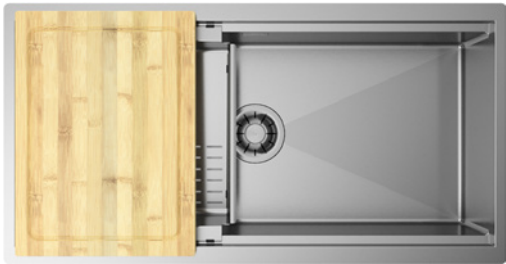

- Wooden chopping board
- Slanted colander

- 2
- 25

 Under mount

Cod. **SBPO 81 L1**

PLANUM ST 81

SOLO



Material	AISI 304
Finishing	Brushed
Corner radius	Welded 10 mm
Overall dimensions	860 x 510 mm
Basin dimensions	810 x 350 mm
Bowl depth	224 mm
Plus Strainer	Ø 3 1/2"
Cabinet	900 mm

 Under mount

Cod. **PO 81 L1**

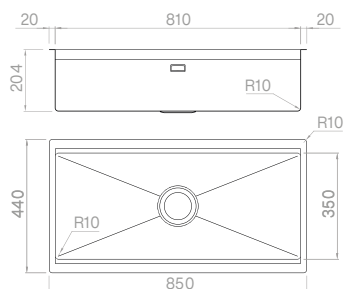

Accessories



See p. 17 for all dedicated accessories.

PLANUM ST 70

READY

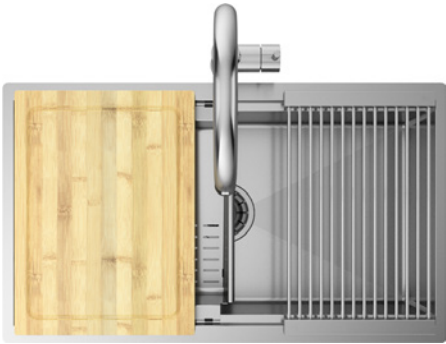

- Wooden chopping board
- Slanted colander
- Grid
- Loft Tap

- 2
- 25
- 11
- 38

 Under mount

Cod. **SAPO 70 L1**

PLANUM ST 70

PRO



- Wooden chopping board
- Slanted colander

- 2
- 25

 Under mount

Cod. **SBPO 70 L1**

PLANUM ST 70

SOLO



Material	AISI 304
Finishing	Brushed
Corner radius	Welded 10 mm
Overall dimensions	750 x 510 mm
Basin dimensions	700 x 350 mm
Bowl depth	224 mm
Plus Strainer	Ø 3 1/2"
Cabinet	800 mm

 Under mount

Cod. **PO 70 L1**

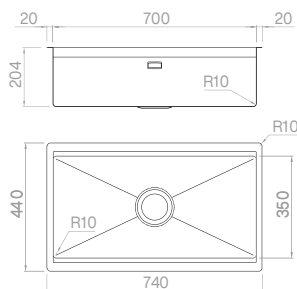

Accessories



See p. 17 for all dedicated accessories.



ARTINOX

Wooden chopping board**2**

300x405x20 mm

Cod. **TRIB 3041****Drainer****9**

250x405x15 mm

Cod. **VPB 2541****Grid****11**

300x407x25 mm

Cod. **GRS 3041****Colander****20**

210x375x60 mm

Cod. **VQSF 2137****Slanted colander****25**

280x370x110/60 mm

Cod. **VQSI 2837****Basin****27**

280x370x140 mm

Cod. **VQSP 2837****Chopping board + gastronorm set****31**

300x405x100 mm

Cod. **TPLB 3V****Chopping board + pasta strainer set****33**

300x405x100 mm

Cod. **TPLB 1S****Chopping board + knife holder frame set****35**

300x405x20 mm

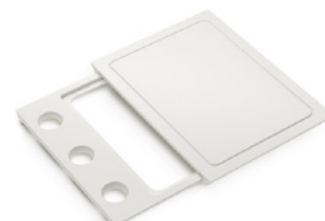
Cod. **TPLB 4030**

Disclaimer

Each product in this catalog is manufactured in compliance to current regulations and CE directives.

All data shown are not binding.

Artinox S.p.a. reserves the right to make changes deemed useful for the improvement of its offer at any time, without notice and disclaiming any responsibility for errors or inaccuracies.

The reproduction of the colors in the catalog are to be considered indicative. Reproductions of all or part of this catalog are prohibited without the specific written authorization of Artinox S.p.a.

© Copyright 2023 Artinox S.p.a. - All rights reserved.

Artinox SpA

Via F. Fabbrì, 39 z.i. Campidui

31015 Conegliano (TV)

Italy

Tel. +39 0438 4531

Mail

Artinox S.p.a. is certified UNI EN ISO 9001 and UNI EN ISO 14001



